

SYSTEM APPLICATION

Single-piece implants



IMMEDIATE LOADING DENTAL IMPLANT SYSTEM

SIMPLADENT®

SIMPLADENT®

Simpladent GmbH
Dorfplatz 11
CH - 8737 Gommiswald / SG
SWITZERLAND

Phone +41 (0)55 293 23 70
implants@simpladent.ch
www.simpladent-implants.com

CONTENT

KOC® instruction for application	5	Scanbodies	33
KOC® Classic implants	13	Instruments and tools	33
KOC® Classic X implants	14	Overview drilling depth and max. working length	34
KOC® B implants with small head for bridges	14	KOC® Mini implants	35
Impression taking and laboratory accessories	15	Surgery	36
KOC® PLUS implants	17	Accessories	37
Example of use of KOC® Plus implants	17	BECES® implants	40
KOC® TX implants	18	Fitting and cementing of prosthetics	41
Insertion tools	18	BECES® implants with small abutment head	42
Impression taking and laboratory accessories	18	BECES® implants with large abutment head	44
Einteilige Multi-Unit implants	19	Use of the handgrip	49
Accessories single-piece Multi-Unit implants	20	BECES® EX implants	49
Application of single-piece Multi-Unit implants	21	STRATEGIC IMPLANT® with small abutment head	50
KDS bone expanding screws	22	STRATEGIC IMPLANT® with large abutment head	51
Insertion tools	23	Accessories for BECES® and KOC® implants	53
Instruments and tools	23	Pathfinder and Twist drills	54
Handgrip	24	Insertion tools and adapter	55
Handgrip tray	24	Intra-oral welding	55
Instrument tray for KOC® and BECES®	25	Instrument tray for KOC® & BECES®	58
Drillstop tray	26	Insertion tools	59
Starter tray	26	Starter tray	59
KOC® implantations	27	Single Piece Implant Pro Kit	60
KOC® M and Micro implants	28	ZDI implants	61
Material / functionality / drilling procedure / insertion	29	Accessories for ZDI implants	61
KOC® M implants with small abutment head	30	ZDI MU implants	62
KOC® Micro implants with large abutment head	30	Accessories for ZDI MU implants	62
KOC® Micro D implants with large abutment head	31	Reprocessing of tools and drills	62
Impression taking and laboratory accessories			

ENDOSSEOUS DENTAL IMPLANT SYSTEM **KOC**[®]

KOC[®] implants are used for crowns, bridges and bars. The compression screw design permits to incorporate the restoration in an immediate loading protocol (incorporation of the prosthesis within max. three days).

KOC[®] implants are routinely used for more than two decades in immediately loading protocols. The single- piece design reduces costs, the danger of peri-implantitis and it eliminates the hazzles of screw loosening. In extraction cases, **KOC**[®] and **BECES**[®] are combined: **BECES**[®] are placed into the fresh sockets, while **KOC**[®] are used in healed bone areas.

KOC[®] Classic implants are straight implants with small prosthetic head for crowns, bridges and bars, for cementation.

KOC® - INSTRUCTION FOR APPLICATION

PREPARATORY WORK

Get your lab to make a drilling template with the specified drill holes for the marking hole.

For the pilot hole, use **DOS 1** or **BCD 1** (yellow) as the primary reamer. Prepare the implant bed with the form drills at full length.

Please use an intermittent drilling technique with good NaCl cooling. If necessary, the laboratory can insert guide sleeves can in the drill holes (code **BFH**) through which the precise direction of drilling can be set.

If, due to high drilling resistance in hard bone, it is difficult to reach the complete drilling depth with **DOS 1**, the correct depth can be reached with the cylinder drill **DS 2** (diameter 2 mm).

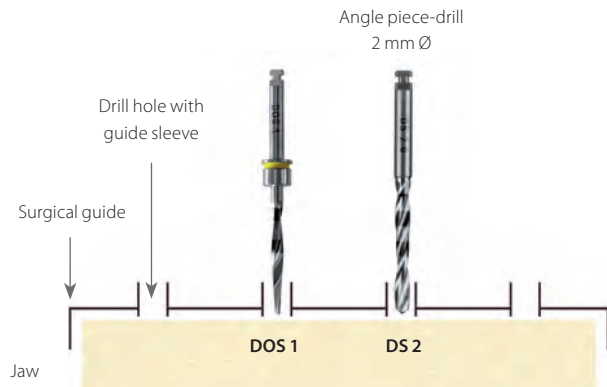

SURGERY

1. Drilling and preparation/compaction of the implant site

DRILL SEQUENCE normal / hard bone				DRILL SEQUENCE soft bone			
Pilot drill	Form drill	KDS	Implant	Pilot drill	Form drill	KDS	Implant
DOS 1	---	KDS 3.0	KOC 3.0	DOS 1	---	---	KOC 3.0
	DOS 2	KDS 3.2	KOC 3.2		---	KDS 3.0	KOC 3.2
	DOS 3 (4)	KDS 3.7	KOC 3.7		DOS 2	KDS 3.2	KOC 3.7
		KDS 4.1	KOC 4.1		KDS 3.7	KOC 4.1	
	DOS 5	KDS 5.0	KOC 5.0		DOS 3 (4)	KDS 4.1	KOC 5.0

In very hard bone the implants should be inserted slightly deeper and then turned back 1/2 round.

DRILL SEQUENCE FOR IMPLANTS WITHOUT MICROTHREAD / WITHOUT MICROGROOVE

Example **KOC 3.7 15**

DOS 2 Depth drill black

BCD 2 black

DS 2 Pilot drill

KDS 3.7 15 for example

TW 2

Angle Piece

IT K Insertion tool

IMPLANTS WITH LARGE HEAD, MICROTHREAD AND MICROGROOVE

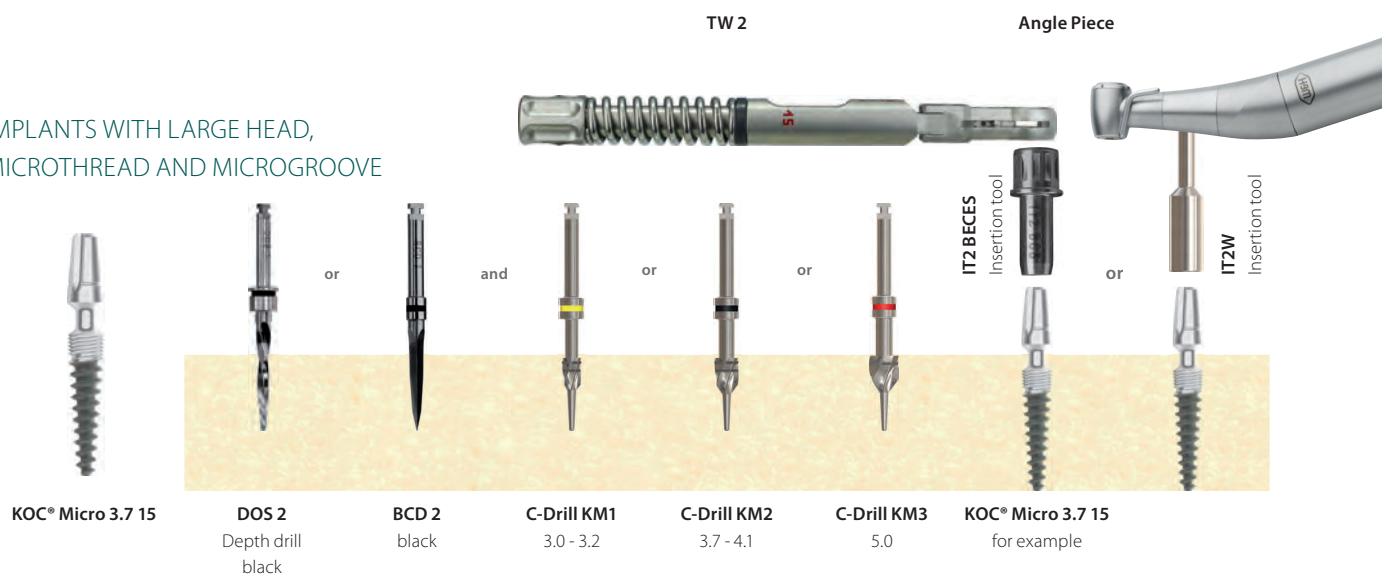

IMPLANTS WITH SMALL HEAD AND MICROTHREAD

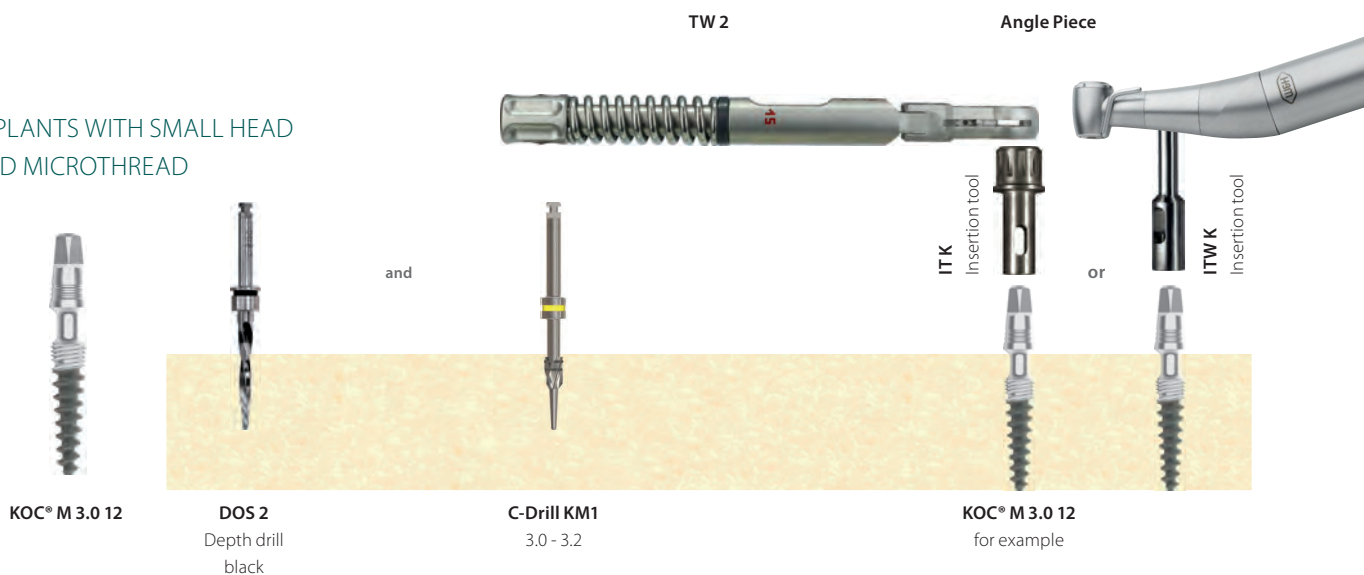

DOS 2/BCD 2 Direction and depth calculation; alternatively BCD 1 „Pathfinder“ drill.

Pilot drill DS 2 For use in hard bone in the cortical region only.

KDS Prepare the implant bed in the maxilla stepwise using the appropriate bone-expanding screw and ratchet or motorized insertion tool. Maximum 40-45 Ncm. Remove the bone-expanding screw again.

KOC® B To create the definitive implant cavity for **KOC® B** implants, it is imperative to use bone-expanding screws. These screws must be screwed to their full depth. They generate the compression and ensure that sufficient space is created for the implant thread in the cortical region.

All **KOC®** implants are used as compression screws. If possible, the hole should be created substantially thinner than the core diameter of the implant, since only in this way can good bone condensation be achieved. The minimum hole diameter depends on the bone density. For this reason, it is not possible to specify drill sequences that can be used favorably for all bone qualities. As a rule, it is necessary to drill much less into the soft maxilla (e.g. the DOS1 drill only can be used for **KOC®** implants with diameter 3.0-5.0) than into the well-mineralized mandible, which requires the use of a drilling sequence adjusted to the bone density.

2. Implant packaging



Original packaging



Open the sealed cover at the lid. Remove the label and place it into the patients record.

3. Remove the implant from its packaging



The open pack contains the implant, mounted to a plastic holder. The pack also contains the lab-set.

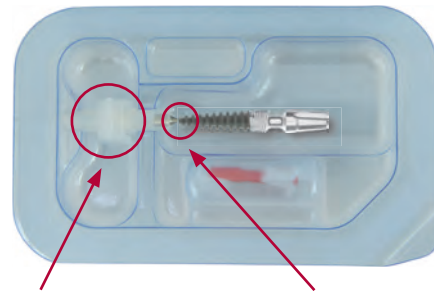

Remove the implant by holding onto the plastic holder

The implant is fixed to the holder by a break joint.

4. Handling

Hold the implant by the holder and place the insertion tool on the implant head. The endosseous implant surface must not be touched. Pull out the implant with the plug and then twist off the plug with the needle holder at the predetermined breaking point.

IMPLANTS WITH LARGE HEAD

KOC® / KOC® Micro

KOC® K (for ball attachment)



Predetermined break line

KOC® implant with insertion tool **IT2W** (for angle piece) and **IT2 BECES** (manual)



KOC® K implant with insertion tool **IT TB K**



Twisting off the bracket with the needle holder

IMPLANTS WITH SMALL HEAD

KOC® (straight) / KOC® B (flexible)



KOC® / KOC® B implants with
insertion tool **ITW K**
(for angle piece) and **IT K** (manual)

Twisting off the bracket with the needle
holder

5. Insertion using manual tools

Insert the implant by hand until it is firmly seated in the jaw.

IMPLANTS WITH LARGE HEAD



IMPLANTS WITH SMALL HEAD

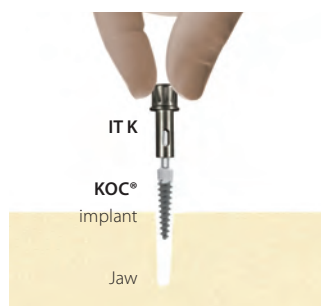

6. Definitive implant insertion

Using the ratchet, torque ratchet or contra-angle, screw the implant clockwise into the cavity. With **KOC® B**, the use of the torque ratchet is mandatory. The endosseous (blasted) part of the implant must be completely covered by bone. The polished implant neck is located in the mucosa. We recommend screwing the implant into the bone up to 1 mm deeper into the implant neck.

IMPLANTS WITH LARGE HEAD

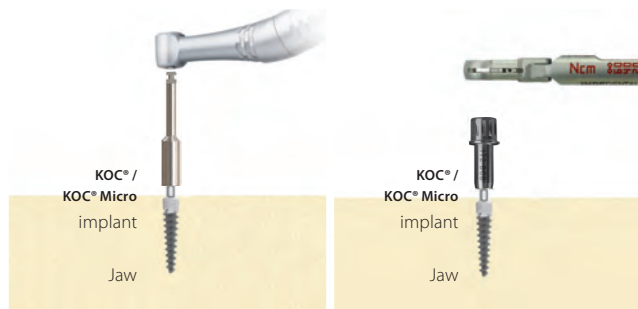

The head of the bendable **KOC® 3.0 & 3.2** and **KOC® Micro (all diameters)** screws can be bent into the desired position after insertion with the aid of the mounted insertion tool and ratchet.

Maximum bend: approx. 15°. Only one bending operation may be performed. In the maxilla, the motorised insertion tool should be used due to its better implant guidance during insertion.



IMPLANTS WITH SMALL HEAD



IMPORTANT NOTE

KOCB® implants have a predetermined breaking point integrated into the head. If the preparation with bone-expanding screws was not performed sufficiently, high screwing forces can cause the upper head portion to be torn off.

So that the implant can be screwed out again, an additional square is milled below the breaking point, into which the emergency tool **Tool E** can be inserted. The **Tool E** instrument may only be used to remove the implant.

7. Removing the placement aid from the implant

IMPLANTS WITH LARGE HEAD

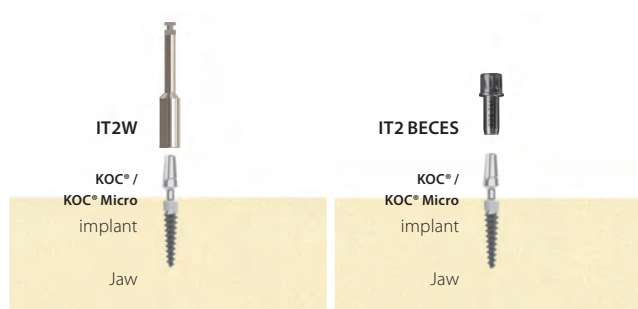

IMPLANTS WITH SMALL HEAD



8. Result

All implant heads (except for the **KOC® K**) can be reshaped by grinding. The implants can be prosthetically supplied immediately if indicated. The definitive superstructure should be cemented within a few days. Immediate prosthetic splinting with a provisional bridge is recommended.

IMPLANTS WITH LARGE HEAD



IMPLANTS WITH SMALL HEAD

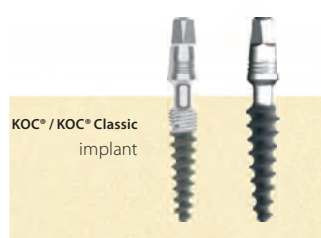

9. Impression

IMPLANTS WITH LARGE HEAD

Bridges



Attachment of the impression post **TSPA 5**, internally round, for **KOC®**

Individual crowns

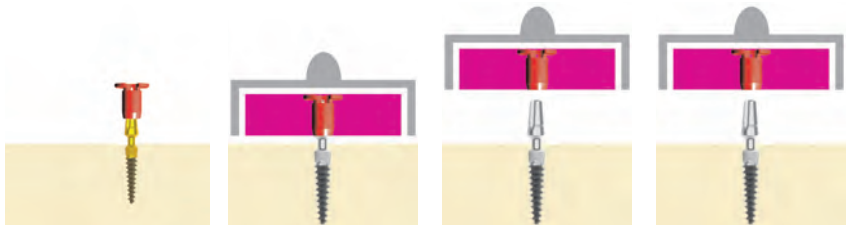

Attachment of the impression post **TSPA 5**, with anti-rotation protection, for **KOC® Micro**

Pressureless impression taking e.g. with **Safepprint®**

Removal of the individual scoop from the implant post. The impression post is located in the impression material. The impression can be sent to the laboratory.

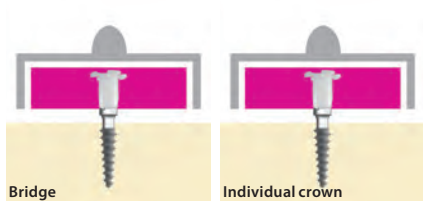

Bridge

Individual crown

Pressureless impression taking e.g. with **Safepprint®**

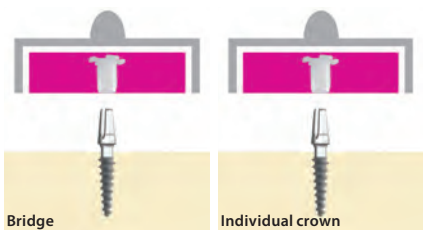

Bridge

Individual crown

Removal of the individual scoop from the implant post. The impression post is located in the impression material. The impression can be sent to the laboratory.

IMPLANTS WITH SMALL HEAD

Bridges / Individual crowns



Individual crown

Attachment of the impression post **TSPA 4**, internally round, for **KOC®** and **KOC® T**

Individual crowns

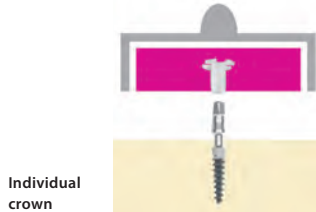

Individual crown

Attachment of the impression post **TSKPA 4**, with anti-rotation protection, for **KOC®** and **KOC® T**

LABORATORY PROCEDURES

Attachment of the impression post onto lab analogues

IMPLANTS WITH LARGE HEAD

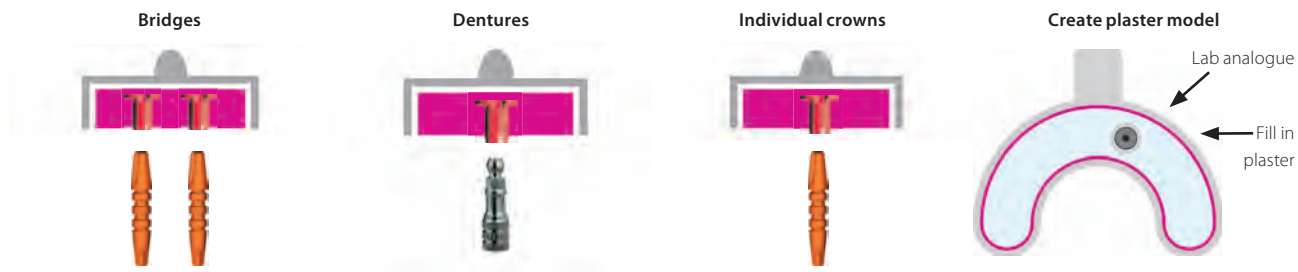

TSPA 5 on IAK M/13-462111

TSPA 5 on IAK

TSPA 5 on IAK M/13-462111

Pull impression from the model. The impression post and analogue are now separated again.



IAK M/13-462111



13-462111

The modeling is performed on the castable parts **PO4** (internally round; for bridges and bars) or **PO4A** (edged inside; for individual crowns).

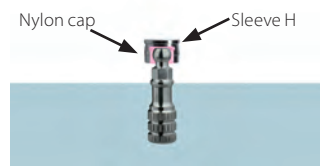

IAK with nylon cap (pink) and sleeve

Polymerization of the sleeve H into the prosthesis. Press **NC/NC1/NC2** into the sleeve. For initial restorations, **NC1** or **NC2** should be used.

IMPLANTS WITH SMALL HEAD

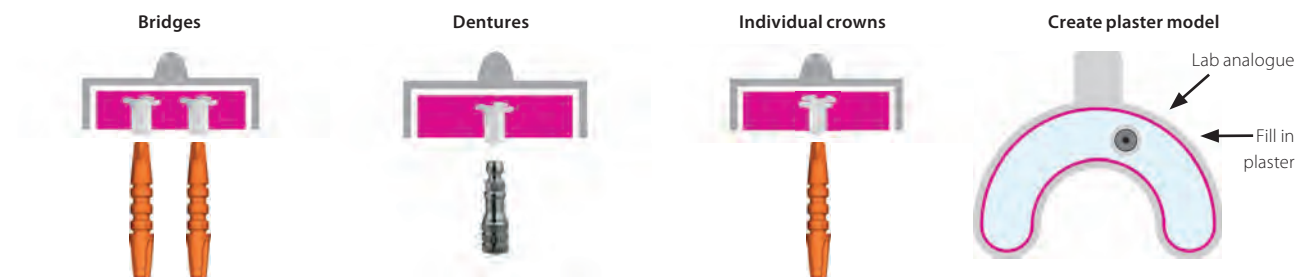

TSPA 4 on IAK M/13-462111

TSPA 4 on IAK

TSKPA 4 on 13-462111

Pull impression from the model. The impression post and analogue are now separated again.



IAK M/13-462111



13-462111

The modeling is performed on the castable parts **PO4** (internally round; for bridges and bars) or **PO4A** (edged inside; for individual crowns).



IAK with nylon cap (pink) and Sleeve

Polymerization of the sleeve H into the prosthesis. Press **NC/NC1/NC2** into the sleeve. For initial restorations, **NC1** or **NC2** should be used.

KOC® IMPLANTS

KOC® CLASSIC IMPLANTS

Straight implants with small head for crowns and bars.

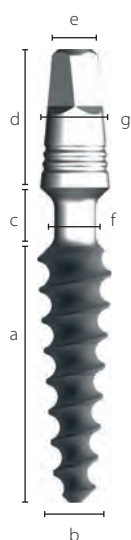

Description	Endosseous Ø	Length	Neck Ø	REF	Price cat.
KOC 3.0 10	3.0 mm	10 mm	2 mm	13-455108	F
KOC 3.0 12	3.0 mm	12 mm	2 mm	13-455109	F
KOC 3.0 15	3.0 mm	15 mm	2 mm	13-455110	F
KOC 3.2 12	3.2 mm	12 mm	2 mm	13-455111	F
KOC 3.2 15	3.2 mm	15 mm	2 mm	13-455112	F
KOC 3.7 6	3.7 mm	6 mm	2.5 mm	13-455106	F
KOC 3.7 8	3.7 mm	8 mm	2.5 mm	13-455107	F
KOC 3.7 10	3.7 mm	10 mm	2.5 mm	13-455114	F
KOC 3.7 12	3.7 mm	12 mm	2.5 mm	13-455115	F
KOC 3.7 15	3.7 mm	15 mm	2.5 mm	13-455120	F
KOC 4.1 8	4.1 mm	8 mm	2.8 mm	13-455129	F
KOC 4.1 10	4.1 mm	10 mm	2.8 mm	13-455130	F
KOC 4.1 12	4.1 mm	12 mm	2.8 mm	13-455132	F
KOC 4.1 15	4.1 mm	15 mm	2.8 mm	13-455135	F
KOC 4.1 17	4.1 mm	17 mm	2.8 mm	13-455136	F
KOC 4.1 19	4.1 mm	19 mm	2.8 mm	13-455137	F
KOC 5.0 10	5.0 mm	10 mm	2.8 mm	13-455171	F
KOC 5.0 12	5.0 mm	12 mm	2.8 mm	13-455172	F
KOC 5.0 15	5.0 mm	15 mm	2.8 mm	13-455173	F

a) endosseus length	6 - 19 mm
b) endosseus Ø	3.0 - 5.0
c) neck length	3.5 mm
d) abutment length	6.8 mm
e) square SW	1.9 mm
f) neck Ø	2.0 / 2.5 / 2.8 mm
g) abutment Ø	3.35 mm

KOC® implants
are delivered **incl. lab-set**
consisting of REF 13-462111,
13-462029 and 13-462088



KOC 3.0 - 3.2	Max. insertion torque 50 Ncm
KOC 3.7 - 5.0	Max. insertion torque 80 Ncm

KOC® CLASSIC X IMPLANTS

KOC® Classic X implants are prosthetically compatible with BECES® implants with diameters 3.6 mm, 4.6 mm and > 5.5 mm, and also with BOI implants.

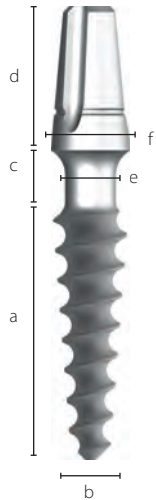



a) endosseous length	8 - 19 mm
b) endosseous Ø	3.7 - 5.0 mm
c) neck length	3.0 mm
d) length abutment	7.2 mm
e) neck Ø	2.5 / 2.8 mm
f) Ø abutment	3.9 mm

Description	endosseous Ø	Length	Neck Ø	REF	Price cat.
KOC X 3.7 10	3.7 mm	10 mm	2.5 mm	13-455720	F
KOC X 3.7 12	3.7 mm	12 mm	2.5 mm	13-455721	F
KOC X 3.7 15	3.7 mm	15 mm	2.5 mm	13-455722	F
KOC X 4.1 8	4.1 mm	8 mm	2.8 mm	13-455730	F
KOC X 4.1 10	4.1 mm	10 mm	2.8 mm	13-455731	F
KOC X 4.1 12	4.1 mm	12 mm	2.8 mm	13-455732	F
KOC X 4.1 15	4.1 mm	15 mm	2.8 mm	13-455733	F
KOC X 4.1 19	4.1 mm	19 mm	2.8 mm	13-455735	F
KOC X 5.0 10	5.0 mm	10 mm	2.8 mm	13-455740	F
KOC X 5.0 12	5.0 mm	12 mm	2.8 mm	13-455741	F
KOC X 5.0 15	5.0 mm	15 mm	2.8 mm	13-455742	F

KOC® X implants are delivered **incl. lab-set** consisting of REF 13-462111, 13-462136 and 13-462086



ACCESSORIES

Analogue IAB	REF 13-462106		Impression post TSPA 5	REF 13-462030
Pack of 5	Price cat. B		Pack of 5	Price cat. B

Red impression caps and red analogue are round.

KOC® B IMPLANTS WITH SMALL HEAD FOR BRIDGES

KOC® B implants with bendable neck (use after pre-drilling and preparation with the bone-expanding screw). Suitable for bridges in the reduced-load range (no individual tooth restorations). The bendable implant now offers dual safety:

1. Torque reduction by pre-compression with the congruent bone-expanding screw
2. Safety head with predetermined breaking point and dual square (Pat. Pend.)

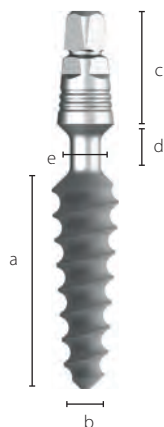

a) endosseous length	12 - 17 mm
b) endosseous Ø	3.2 / 4.1 mm
c) length abutment	6.8 mm
d) neck length	3.0 mm
e) neck Ø	1.8 mm



Description	Code KDS	endosseous Ø	Length	REF	Price cat.
KOC B 3.2 12	D	3.2 mm	12 mm	13-455162	F
KOC B 3.2 15	E	3.2 mm	15 mm	13-455161	F
KOC B 3.7 12	F	3.7 mm	12 mm	13-455164	F
KOC B 3.7 15	G	3.7 mm	15 mm	13-455165	F
KOC B 4.1 15	L	4.1 mm	15 mm	13-455166	F
KOC B 4.1 17	M	4.1 mm	17 mm	13-455167	F

The predetermined fracture site integrated in the abutment prevents the twisting off of the abutment head from the endosseous implant part. The implant socket has to however always be pre-compressed using the bone-expanding screw. **Max. insertion torque 45 Ncm.**

KOC® B implants are delivered **incl. lab-set** consisting of REF 13-462111, 13-462029 and 13-462088



IMPRESSION TAKING AND LABORATORY ACCESSORIES



	Description	Unit	Material	Code	REF	Price cat.
	Impression post castable, Internally round	Pack of 5		TSPA 4	13-462029	B
	Impression post castable, internal edges	Pack of 5		TSKPA 4	13-462028	B
	Double analogue	Pack of 5	plastic	IA4/IAU	13-462111	B
or						
	Double analogue	Single	metal	IA4/IAU	13-462112	A
	Castable abutment and base for provisionals. 7 mm high, white, Internally round	Pack of 5		PO4	13-462088	B
	Castable abutment and base for provisionals. 7 mm high, white, internally edged	Pack of 5		PO4A	13-462089	B

***TSPA 4 & 5** For impressions on ground-down implant heads.

The ring transfer constitutes the lower limit of the head, so that the impression can be poured with die stone or epoxy. The use of an implant analogue together with transfer 4 is not possible with ground-down implant heads. Material: PP

SCAN ANALOGUE

Scanner analogue for large and small implant head, self-descriptive. These analogues do not need to be sprayed with spray paint. They can be pulled out of the model with anti-rotation protection. Matching impression posts: **TSPA 4** and **TSPA 5**.

	Description	REF	Price cat.
IAS 4 	Scan analogue IAS 4	13-462019	B
IAS 5 	Scan analogue IAS 5	13-462020	B

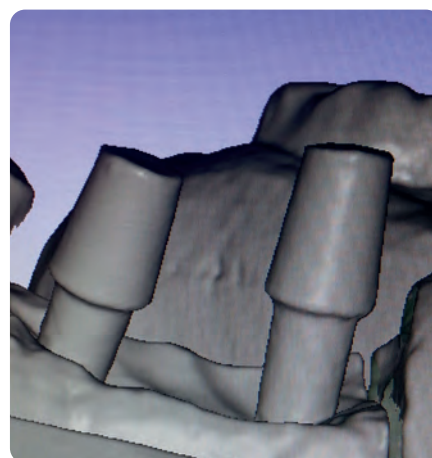



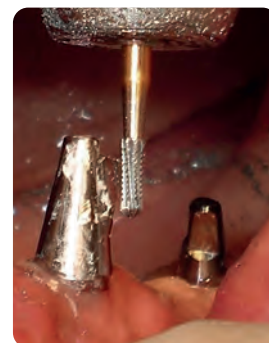

Use example for self-descriptive scanner analogue.

CEMENTABLE ANGULATION ADAPTER (Ti6AL4V)

These adapters are mounted on **KOC®** implants to compensate for the insertion direction. Plastic cements are preferably used. The implant head must be roughened beforehand. The protruding head parts are then removed. The impression is taken directly on the adapter.



	Description	Code	REF	Price cat.
	Adapter, 15° for small head	AA15 KK	13-462036	C
	Adapter, 25° for small head	AA25 KK	13-462046	C
	Adapter short, for large head	AA5 15°	13-462052	C
	Adapter short, for large head	AA5 25°	13-462053	C

CASTABLE CROWN BASE

These adapters are used by the dental technician for modeling of bridge frames. In the metal try-in, the protruding head parts are removed by the dentist.

	Description	Height	Code	REF	Price cat.
	Adapter Reducible Pack of 5	7.5	AAL 15 KK	13-462045	E

LAB ANALOGUE

	Description	Code	REF	Price cat.
	Abutment analogue for angulation adapter 15° and 25°	AAA	13-462049	B

CASTABLE PART AND IMPRESSION CAP

	Description	Code	REF	Price cat.
	Castable abutment and transfer for AAA Pack of 5	PA AAA	13-462050	A

KOC® PLUS IMPLANTS

KOC® PLUS are made in one piece and have a polished apical cutting thread for anchorage in the opposite cortical. **KOC® Plus** combines the advantages of the compression screw with the advantages of the bicortical screw: in addition to bone compression, there is also anchorage in the 2nd cortical (opposite cortical). Can be used in the maxilla and mandible. Made of titanium alloy Ti6Al4V, lasered. Tighten with **IT2 BECES**.



Description	Compression thread	Endosseous length	REF	Price cat.
KOC 3.7 9+3	9 mm	12 mm	13-455800	G
KOC 3.7 11+3	11 mm	14 mm	13-455801	G
KOC 3.7 13+3	13 mm	16 mm	13-455802	G
KOC 3.7 16+3	16 mm	19 mm	13-455803	G
KOC 3.7 20+3	20 mm	23 mm	13-455804	G
KOC 4.1 6+3	6 mm	9 mm	13-455810	G
KOC 4.1 9+3	9 mm	12 mm	13-455811	G
KOC 4.1 11+3	11 mm	14 mm	13-455812	G
KOC 4.1 13+3	13 mm	16 mm	13-455813	G
KOC 4.1 20+3	20 mm	23 mm	13-455814	G
KOC 5.0 6+3	6 mm	9 mm	13-455820	G
KOC 5.0 9+3	9 mm	12 mm	13-455821	G
KOC 5.0 11+3	11 mm	14 mm	13-455822	G
KOC 5.0 13+3	13 mm	16 mm	13-455823	G

a) endosseous length	9 - 26 mm
b) endosseous compression region	6 - 23 mm
c) area for 2 nd cortical engagement	3.0 mm
d1) max. endosseous Ø	3.7 / 4.1 / 5.0 mm
d2) apical thread Ø	4.5 mm
e) mucosal zone	3.5 mm
f) height of platform	7.2 mm
g) max. head Ø	3.9 mm
h) neck Ø	2 mm

KOC® Plus implants are delivered **incl. lab-set** consisting of REF 13-462111, 13-462136 and 13-462086



Max. insertion torque 80 Ncm.

ACCESSORIES

Analogue IAB	REF 13-462106		Impression post TSPA 5	REF 13-462030
Pack of 5	Price cat. B		Pack of 5	Price cat. B

Red impression caps and red analogue are round.

EXAMPLE OF USE OF KOC® PLUS IMPLANTS



Bicortical anchorage of a **KOC® Plus** implant in the atrophied distal mandible.

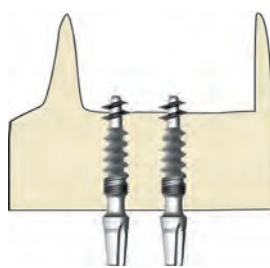

Bicortical anchorage of a **KOC® Plus** implant in the area of the nasal floor.

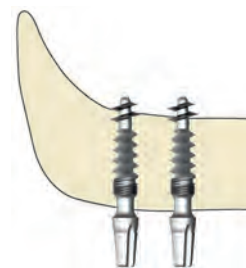

Bicortical anchorage of **KOC® Plus** implants (Ø 3.7 and 4.1) in the area of the maxillary sinus.

NOTE - KOC® Plus may only be operated/used by validly authorized users. Only polished implant parts may penetrate a maximum of 1.5 mm into the opposite cortical. For a given indication (min. three stable implants, sufficient bone quality, etc.). **KOC® Plus** are suitable for immediate loading.

KOC® TX IMPLANTS

KOC® TX is a compression screw implant with an extended polished and bendable neck (6 mm) for anchorages in the tuberosity and in regions with large mucosal thickness. The roughened thread parts must be completely submerged in the bone. **KOC® TX** is preferably used without flap preparation. The nominal diameter is reached at the widest part of the compression thread.

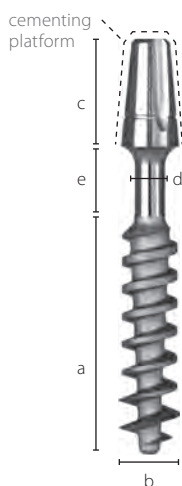

Description	Max. endosseous Ø	REF	Price cat.	Description	Max. endosseous Ø	REF	Price cat.
KOC TX 3.0 12	3 mm	13-455001	F	KOC TX 3.7 18	3.7 mm	13-455007	F
KOC TX 3.0 15	3 mm	13-455002	F	KOC TX 4.0 12	4 mm	13-455175	F
KOC TX 3.0 18	3 mm	13-455003	F	KOC TX 4.0 15	4 mm	13-455176	F
KOC TX 3.7 12	3.7 mm	13-455005	F	KOC TX 4.0 18	4 mm	13-455177	F
KOC TX 3.7 15	3.7 mm	13-455006	F	KOC TX 4.0 21	4 mm	13-455178	F

Max. insertion torque 80 Ncm.

a) endosseous length	12 - 21 mm
b) max. endosseous Ø	4 mm
c) abutment length	7.2 mm
d) neck Ø	2 mm
e) neck height	6 mm

KOC® TX implants are delivered **incl. lab-set** consisting of REF 13-462111, 13-462136 and 13-462086



ACCESSORIES

Analogue IAB	REF 13-462106
Pack of 5	Price cat. B



Impression post TSPA 5	REF 13-462030
Pack of 5	Price cat. B

Red impression caps and red analogue are round.

INSERTION TOOLS



Description	Code	REF	Price cat.
Insertion tool medium, for large head. Use with RAT2 and TW2. For BECES implants with > Ø 5.5 mm, KOC X, KOC XB, KOC Plus	IT2 BECES	13-900030	E
Length 23 mm, for KOC and BECES implants	IT2 S BECES	13-900038	E
Adapter for implants > Ø 5.5 mm, for handgrips REF 13-311431, 13-311431 / KOC X, KOC XB	IT2W	13-900039	C
	AHB	13-900037	F

IMPRESSION TAKING AND LABORATORY ACCESSORIES

Description	Unit	Material	Code	REF	Price cat.
Impression post castable, internally round	Pack of 5	POM	TSPA 5*	13-462030	B
Impression post castable, Internally edged	Pack of 5		PA X	13-462136	B
Double analogue	Pack of 5	plastic	IA4/IAU	13-462111	B
Double analogue		metal	IA4/IAU	13-462112	A
Castable abutment	Pack of 5		POB	13-462086	B

PA X will be sold in the color orange, starting 01-2018

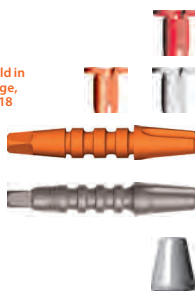

*TSPA 4 & 5 For impressions on ground-down implant heads. This ring-transfer exposes the lower border of the abutment head. The impression is then poured with extra-strong gypsum or epoxy-resin. For this techniques no implant analogues are needed. Material: PP

SINGLE-PIECE MULTI-UNIT IMPLANTS

KOC® MU implants feature a pre-angulation of 15 degrees. **KOC® MU** may be bent additionally, using the insertion tool. In conjunction with the clinically possible rotational positions of the head, virtually all possible angulations can be realized. Material **Ti6Al4V**.

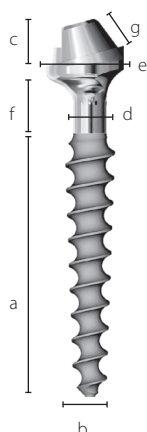

a) endosseous length	10 - 15 mm
b) endosseous Ø	3.0 - 5.0 mm
c) high abutment	3.7 mm
d) shaft Ø	2 mm
e) platform Ø	4.8 mm
f) trans-mucosal height	3 mm
g) height of connecting part	2 mm
Prosthetic screw	SFK MU

Description	REF	Price cat.
KOC MU 3.0 15	13-455830	L
KOC MU 3.2 12	13-455838	L
KOC MU 3.2 15	13-455839	L
KOC MU 3.7 10	13-455840	L
KOC MU 3.7 12	13-455841	L
KOC MU 3.7 15	13-455831	L
KOC MU 4.1 12	13-455832	L
KOC MU 4.1 15	13-455833	L
KOC MU 5.0 10	13-455834	L
KOC MU 5.0 12	13-455835	L

BECES® MU implants feature a pre-angulation of 15 degrees. **BECES® MU** may be bent additionally, using the insertion tool. In conjunction with the clinically possible rotational positions of the head, virtually all possible angulations can be realized. **BECES® MU** implants may be used by authorized users only. Material **Ti6Al4V**.

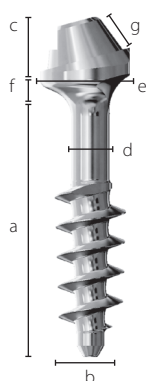

a) endosseous length	8 - 38 mm
b) endosseous Ø	3.6 - 7.0 mm
c) high abutment	3.7 mm
d) shaft Ø	2 mm
e) platform Ø	4.8 mm
f) neck height	0.8 mm
g) height of connecting part	2 mm
Prosthetic screw	SFK MU















Description	REF	Price cat.	Description	REF	Price cat.
BECES MU 3.6 8	13-900397	N	BECES MU 4.6 23	13-900385	N
BECES MU 3.6 10	13-900398	N	BECES MU 4.6 26	13-900386	N
BECES MU 3.6 12	13-900376	N	BECES MU 4.6 29	13-900387	N
BECES MU 3.6 14	13-900330	N	BECES MU 4.6 32	13-900388	N
BECES MU 3.6 17	13-900331	N	BECES MU 4.6 35	13-900389	N
BECES MU 3.6 20	13-900332	N	BECES MU 5.5 10	13-900334	N
BECES MU 3.6 23	13-900333	N	BECES MU 5.5 12	13-900335	N
BECES MU 3.6 26	13-900377	N	BECES MU 5.5 14	13-900336	N
BECES MU 3.6 29	13-900378	N	BECES MU 5.5 17	13-900357	N
BECES MU 3.6 32	13-900399	N	BECES MU 5.5 20	13-900358	N
BECES MU 3.6 35	13-900339	N	BECES MU 5.5 23	13-900341	N
BECES MU 3.6 38	13-900340	N	BECES MU 5.5 26	13-900342	N
BECES MU 4.6 8	13-900379	N	BECES MU 7.0 10	13-900337	N
BECES MU 4.6 10	13-900380	N	BECES MU 7.0 12	13-900338	N
BECES MU 4.6 12	13-900381	N	BECES MU 7.0 14	13-900360	N
BECES MU 4.6 14	13-900382	N	BECES MU 7.0 17	13-900361	N
BECES MU 4.6 17	13-900383	N	BECES MU 7.0 20	13-900362	N
BECES MU 4.6 20	13-900384	N			

MULTI-UNIT LAB SET



Description	Code	REF	Price cat.
Titanium base Use with SF K MU	T-Base MU	13-418188	
Castable abutment Use with T-Base and SF K MU	PA2 MU	13-418189	
Prosthetic screw For KOC® MU and BECES® MU	SF K MU	13-418164	
COMPLETE SET		13-418289	D

ACCESSORIES SINGLE-PIECE MULTI-UNIT IMPLANTS

	Description		Code	REF
	Insertion tool for KOC® MU, BECES® MU & Hexacone Plus MU 15°. Use with IT2 BECES, IT2 S BECES, AH MU. Tool: HT 1.25		ITX MU15	13-418203
	Insertion tool medium, for large head. Use with RAT2 and TW2. Length 19 mm		IT2 BECES	13-900030
	Insertion tool short, for large head. Use with RAT2 and TW2. Length 7 mm		IT2 S BECES	13-900038
	Adapter for handgrip Fits ITX MU15 (REF 13-418203)		AH MU	13-900041
	Scan abutment for MU implants, incl. screw SSA MU. Sterilisable, two-part. Material Ti6Al4V		SAB MU	13-418205
Parts for passive connection of the bridge frame		Prosthetic screw for KOC® MU and BECES® MU	SF K MU	13-418164
		Castable abutment for use with T-Base and SF K MU	PA2 MU	13-418189
		Titanium base* Use with SF K MU (REF 13-418164), for Hexacone Plus MU, BECES® MU, KOC® MU	T-Base MU	13-418188
Parts for UCLA technique		Prosthetic screw for KOC® MU and BECES® MU	SF K MU	13-418164
		Castable abutment UCLA for direct use on MU-implants. SF K MU sold separately	PA MU	13-418119
Part for UCLA technique & passive connection		Digital lab analogue for MU-implants* For BECES® MU, KOC® MU, Hexacone® MU	IA K MU	13-418159
	Long screw for prosthetic use or as pick-up screw for use with HLT MU (Tool: HT 1.25). Material Ti6Al4V		SFL MU	13-418168
	Transfer for pick-up impressions, straight. Delivery incl. SFL MU		HLT MU	13-418162
	Temporary base SF K MU or SFL MU must be ordered separately		TC MU	13-418161
	Hex-instrument 1.25, length 14 mm	short	HTS 1.25	13-425101
	Hex-instrument 1.25, length 21 mm	medium	HT 1.25	13-425100
	Hex-instrument, length 45 mm	long	HTX 1.25	13-425102

* EXTENSION SET FOR SMALL TRAY

Works with all MU implants

APPLICATION OF SINGLE-PIECE MULTI-UNIT IMPLANTS

1.

Tighten screw SFL MU with the tool HT 1.25.

Fix the transfer with the long screw, then take pick-up-impresion.

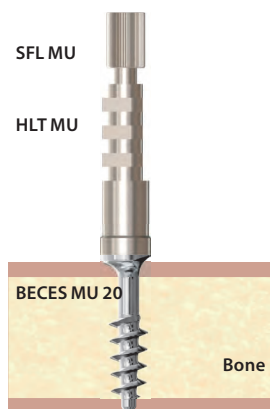

4.

T-Base is sandblasted **from the outside** and cleaned.

The bridge frame is sandblasted **from below in the area of the implants**.



2.

Connect the transfer to the implant analogue (IA K MU) and pour the impression with gypsum.

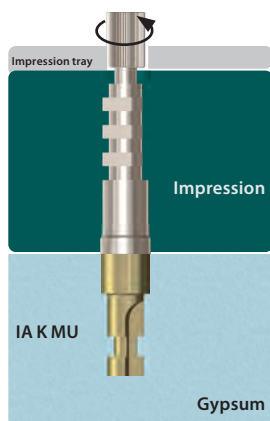

5.

All T-Base are fixed to the implants with SF K MU or the long screw SFL MU. Then all T-Base are glued with adhesive cement to the bridge frame.

This guarantees a passive fit. Composite excess is removed and the site is polished.



3. a

Connect PA MU with SF K MU on the analogue IA K MU. Tighten screw SFL MU with the tool HT 1.25.

Now the modulation can be created and the frame is veneered. Veneering is possible with acryl, composite and ceramics.

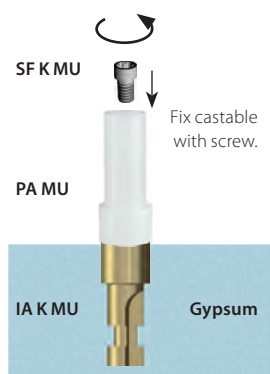

6.

Now the bridge may be screwed on passive with SF K MU.

Screw canals are closed with temporary filling material or composite, taking into consideration that later access must be possible.

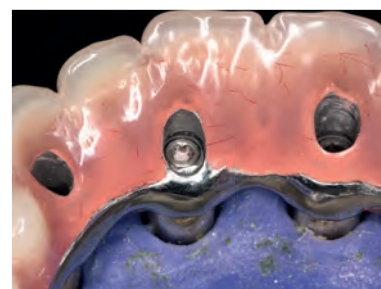

3. b

T-Base is positioned over the analogue and screwed on with SF K MU. The cartable PA2 MU is then fitted on top of the T-Base.

Now the modulation is made. Veneering is possible with acryl, composite and ceramics.

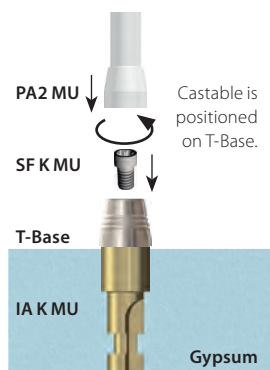

Application of insertion tool MU

Example for insertion tool ITX MU15 on the implant BECES® MU / KOC® MU.



KDS BONE EXPANDING SCREWS

For all **KOC® B** screw implants, bone-expanding screws are available as tools to create the definitive implant cavity. Basically, for each implant prior to insertion of a **KOC® B** screw implant, a bone compression with the bone-expanding screw should be performed. In addition, with a narrow alveolar ridge, an expansion of the alveolar ridge can be performed with the bone-expanding screw. By inserting the bone-expanding screw, it can be checked whether the **KOC® B** screw implant can be inserted into the bone easily and fully. Titanium alloy Ti6Al4V Eli, machined. Tighten with **IT K**, **ITS K** or **ITX K** using the torque ratchet **TW2** (max. 45 Ncm), or alternatively **RAT2**.
Package unit: 1 piece, non-sterile.

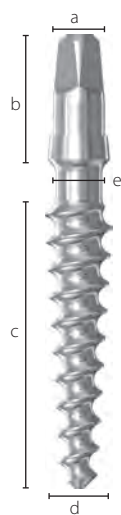

a) endosseous length	8 - 19 mm
b) endosseous Ø	3.0 / 3.2 / 3.7 / 4.1 / 5 mm
c) length (non-blasted)	10 mm
d) length abutment	6.8 mm
e) neck Ø	2.0 - 2.8 mm
f) neck length	3 mm

Description	Code KDS	Endosseous Ø	Length	Neck Ø	REF	Price cat.
KDS 3.0 10	A	3.0 mm	10 mm	2.0 mm	13-455212	F
KDS 3.0 12	B	3.0 mm	12 mm	2.0 mm	13-455213	F
KDS 3.0 15	C	3.0 mm	15 mm	2.0 mm	13-455214	F
KDS 3.2 12	D	3.2 mm	12 mm	2.5 mm	13-455223	F
KDS 3.2 15	E	3.2 mm	15 mm	2.5 mm	13-455224	F
KDS 3.7 12	F	3.7 mm	12 mm	2.8 mm	13-455233	F
KDS 3.7 15	G	3.7 mm	15 mm	2.8 mm	13-455234	F
KDS 4.1 8	H	4.1 mm	8 mm	2.8 mm	13-455241	F
KDS 4.1 10	I	4.1 mm	10 mm	2.8 mm	13-455242	F
KDS 4.1 12	K	4.1 mm	12 mm	2.8 mm	13-455243	F
KDS 4.1 15	L	4.1 mm	15 mm	2.8 mm	13-455244	F
KDS 4.1 17	M	4.1 mm	17 mm	2.8 mm	13-455245	F
KDS 4.1 19	N	4.1 mm	19 mm	2.8 mm	13-455246	F

The bone-expanding screws can easily be screwed in using suitable insertion tools and immediately screwed out again after reaching the full insertion depth. Subsequently, the **KOC® B** implant is inserted. With the **KOC® B** (bendable), **the use of bone-expanding screws is mandatory regardless of the region**, so that the shear forces occurring during insertion do not fracture the implant neck.

Do not use for KOC® implants with microthread.





INSERTION TOOLS

	Description	Type	Length	Code	REF	Price cat.
	For KOC, KOC B, KDS	long	20 mm	IT K	13-462320	C
	For KOC, KOC B, KDS	extra long	45 mm	ITX K	13-462321	C
	For KOC, KOC B, KDS	short	7 mm	ITS K	13-462322	C
	For KOC, KOC B, KDS	contra-angle / hex	23 mm	ITWH K *	13-462323	C
	For KOC, KOC B, KDS	contra-angle	23 mm	ITW K	13-462331	C
	For KOC K	long	20 mm	ITTB K	13-462327	D
	For KOC B **	long	20 mm	Tool E **	13-462377	D

* Only for W+H contra-angles with new drive



** Emergency tool for retrieving KOC® B

INSTRUMENTS AND TOOLS

	Description	Length	Code	REF	Price cat.
	Drill extension extends by 19 mm		DX 2	13-500704	D
	Standardized probe 1-mm scale for radiological measurements	22 mm	PDG	13-425400	A
	Radiological measure pin Fits to DOS 1		CDG	13-420329	A
	Ratchet for all hex instruments and insertion tools		RAT2	13-425051	K
	Torque wrench 10-70 Ncm		TW2 *	13-425402	S

* It is recommended to have the torque ratchets recalibrated by us once a year.

HARD METAL BONE CUTTER

	Description	Length	Code	REF	Price cat.
	Hard metal bone cutter short	30 mm	SHMCS	13-90030	F
	Hard metal bone cutter long, for FG	36 mm	SHMCL	13-90031	F

HANDGRIP SELF LOCKING

Please note the cleaning instructions on p. 57-58-61 of this system application brochure.



Length
110 mm
REF
311431
Price cat.
V



DRILLS

Description	Length	Code	REF	Price cat.
Adapter	100mm	BCD 1 Adapter	13-310511	F
Twist Drill	110 mm	Twist Drill 2.0	13-310512	F

ADAPTER

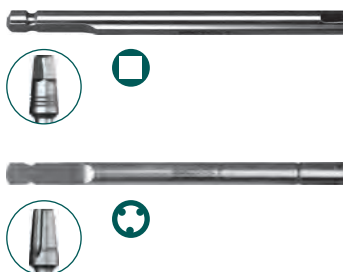

Description	Length	Code	REF	Price cat.
For KOC®, KOC® B, KOC® T, KOC® KDS, BECES 3.5, BECES 4.5	70 mm	Adapter AHK	13-462319	D
For KOC® X, KOC® XB, KOC® Plus, BECES 3.6, BECES 4.6, from > 5.5	70 mm	Adapter AHB	13-900037	F

HANDGRIP TRAY

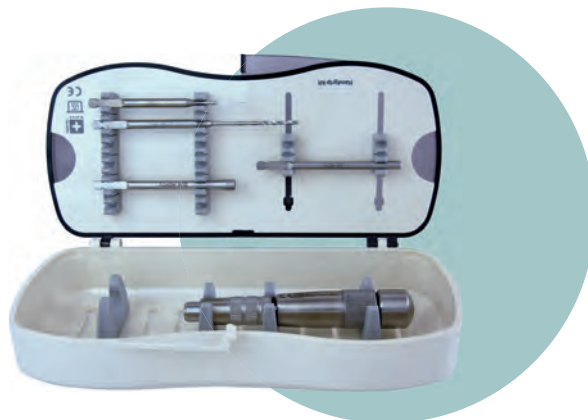

Size of closed tray
B 195 mm T 90 mm H 45 mm
For all autoclaves

Description	Length	REF	Description	Length	REF
BCD 1 Adapter	100 mm	13-310511	Handgrip	110 mm	13-311430
Twist Drill 2.0	110 mm	13-310512	Handgrip tray empty		13-60043
Adapter AHK	70 mm	13-462319	Handgrip tray with content		13-S60043
Adapter AHB	70 mm	13-900037			

ACCESSORIES



Description	REF
Replacement O-ring for demountable handgrip 311430	13-311430-OR

INSTRUMENT TRAY FOR KOC® & BECES®



Size of closed tray
B 175 mm **T** 145 mm **H** 65 mm
 For all autoclaves. Autoclaveable up to 134°C,
 not suitable for dry heat sterilizers.

Description	System	Head	REF	Description	System	REF	Price €
IT2 BECES	KOC/BECES	large	13-900030	Twist Drill 2.0 30	BECES	13-90020	
IT2 S BECES	KOC/BECES	large	13-900038	Twist Drill 2.0 21	BECES	13-90022	
IT2 W	KOC/BECES	large	13-900039	Twist Drill 2.5 21	BECES	13-90026	
IT K	KOC/BECES	small	13-462320	BCD 1	KOC/BECES	13-900240	
ITS K	KOC/BECES	small	13-462322	BCD 2	KOC/BECES	13-900241	
ITW K	KOC/BECES	small	13-462331	BCD 3	KOC/BECES	13-900242	
ITWH K	KOC/BECES	small	13-462323	BCDX 1	KOC/BECES	13-900243	
DOS 1	KOC		13-455311	BCDX 2	KOC/BECES	13-900244	
DOS 2	KOC		13-455312	BCDX 3	KOC/BECES	13-900245	
DOS 3	KOC		13-455313	CDG	KOC/BECES	13-420329	
DOS 4	KOC		13-455314	CDG	KOC/BECES	13-420329	
DOS 5	KOC		13-455315	DX 2	KOC/BECES	13-500704	
C-Drill KM 1	KOC		13-455300	TW 2	KOC/BECES	13-425402	
C-Drill KM 2	KOC		13-455301				
C-Drill KM 3	KOC		13-455302	Instrument tray empty		13-60006-K	upon request
IT LOCK	KOC		13-462333	Instrument tray with content		13-560006-K	upon request
DS 2	KOC		13-425001				
IT TB K	KOC		13-462327				

The content for the system BECES® is optional

DRILL-STOP TRAY



Not suitable for dry heat sterilizers.

Depth	Drills	Drillstop	Depth	Drills	Drillstop
KOC 3.0 (3.2)					
10	DOS 1	K	8	DOS 3	L
12	DOS 1	H	10	DOS 3	K
15	DOS 1	D	12	DOS 3	H
KOC 3.7					
10	DOS 2	K	15	DOS 4	K
12	DOS 2	H	17	DOS 4	H
15	DOS 2	D	19	DOS 4	F
KOC 5.0					
10	DOS 5 (6)	K			
12	DOS 5 (6)	H			
15	DOS 5 (6)	D			

Description	REF	Price €
Drillstopp B	13-500882	
Drillstopp C	13-500883	
Drillstopp D	13-500884	
Drillstopp F	13-500886	
Drillstopp H	13-500888	
Drillstopp K	13-500891	
Drillstopp L	13-500892	
Drill DOS 1	13-455311	
Drill DOS 2	13-455312	
Drill DOS 3	13-455313	
Drill DOS 4	13-455314	
Drill DOS 5	13-455315	
Drill DOS 6	13-455316	
Drillstopp tray with content	60033-K	498.00

IT HAS BEEN SCIENTIFICALLY PROVEN

Heatless® drills by Dr. Ihde Dental generate 55 % less heat than traditional bone drills from other manufacturers. This makes it possible to use higher rotational speeds: between 3,000 and 5,000 rpm are recommended with good external cooling and intermittent drill technique.

STARTER TRAY

Autoclaveable up to 134° C, not suitable for dry heat sterilizers.
This surgical kit contains all drills and tools for first works with the system KOC®.
Material: autoclaveable plastic.



Description	REF	Price €
IT K	13-462320	
ITS K	13-462322	
C-Drill KM 1	13-455300	
C-Drill KM 2	13-455301	
C-Drill KM 3	13-455302	
IT 2 BECES	13-900030	
IT 2 S BECES	13-900038	
DOS 1	13-455311	
DOS 2	13-455312	
DOS 3	13-455313	
BCDX 1	13-900243	
Torque wrench TW2	13-425402	
HT 1.25	13-425100	
ITX MU 15	13-418203	
Starter tray empty	13-60041-K	upon request
Starter tray with content	13-S60041-K	upon request

optional
content

KOC® IMPLANTATIONS

Minimally invasive immediate load implantology with **KOC®** implants

1. Insertion of 21 **KOC®** implants in three hours.
2. Maxilla restoration with new motorized screwing technology.
3. Minimally invasive approach for beginners.

Authors

Dr. Werner Mander, (IMF) Dr. Thomas Fabritius



Description	REF	Price cat.
DVD	13-6668	A

INDICATIONS **KOC® II KOC® MICRO**

- Anchorage of crowns, bridges and bars, with the presence of adequate bone supply in terms of bone quality, bone width and bone height.
- Anchorage of prostheses via bar and button anchorage systems.
- Not for use in combination with simultaneous bone augmentations

RESTRICTIONS FOR **KOC® B** APPLICATION

- These two implant types may only be used as support implants in the reduced-load area.
- Splinting of at least three and possibly several implants for cross arch stabilisation.
- At least one **KOC®** or **KOC® Micro** implant must be involved in the construction.
- The prosthetic restoration must be securely fixed (with definitive cements).
- Not to be used for segmented bridges without the involvement of at least two **KOC®** screws.
- If in doubt, angulation adapters on **KOC®** screws are preferable to the **KOC® B** implant.
- Not to be used for additional abutments in combination with natural teeth.
- Not to be used under off-axis load as well as in deep-bite cases in the maxillary and mandibular anterior region.
- Max. width of occlusal surface 5 mm.
- Not to be used as terminal abutments.
- Bendable up to 13 degrees.

NOTES ON THE CARE OF SURGICAL STEEL INSTRUMENTS

Surgical steel instruments can quickly become damaged if inadequately or improperly cared for. Only the special solvents for cleaning surgical steel should be used; in case of doubt, consult **Dr. Ihde Dental GmbH / AG**.

The following are not recommended:

- Disinfectants/cleaners with a high chlorine content.
- Disinfectants/cleaners with a high oxalic acid content.



For instruments with colour coding, the following are NOT recommended:

- Excessively high solvent concentrations, disinfectants/cleaners with the components mentioned above.
- Excessive temperatures during cleaning and sterilization (no dry heat sterilization).

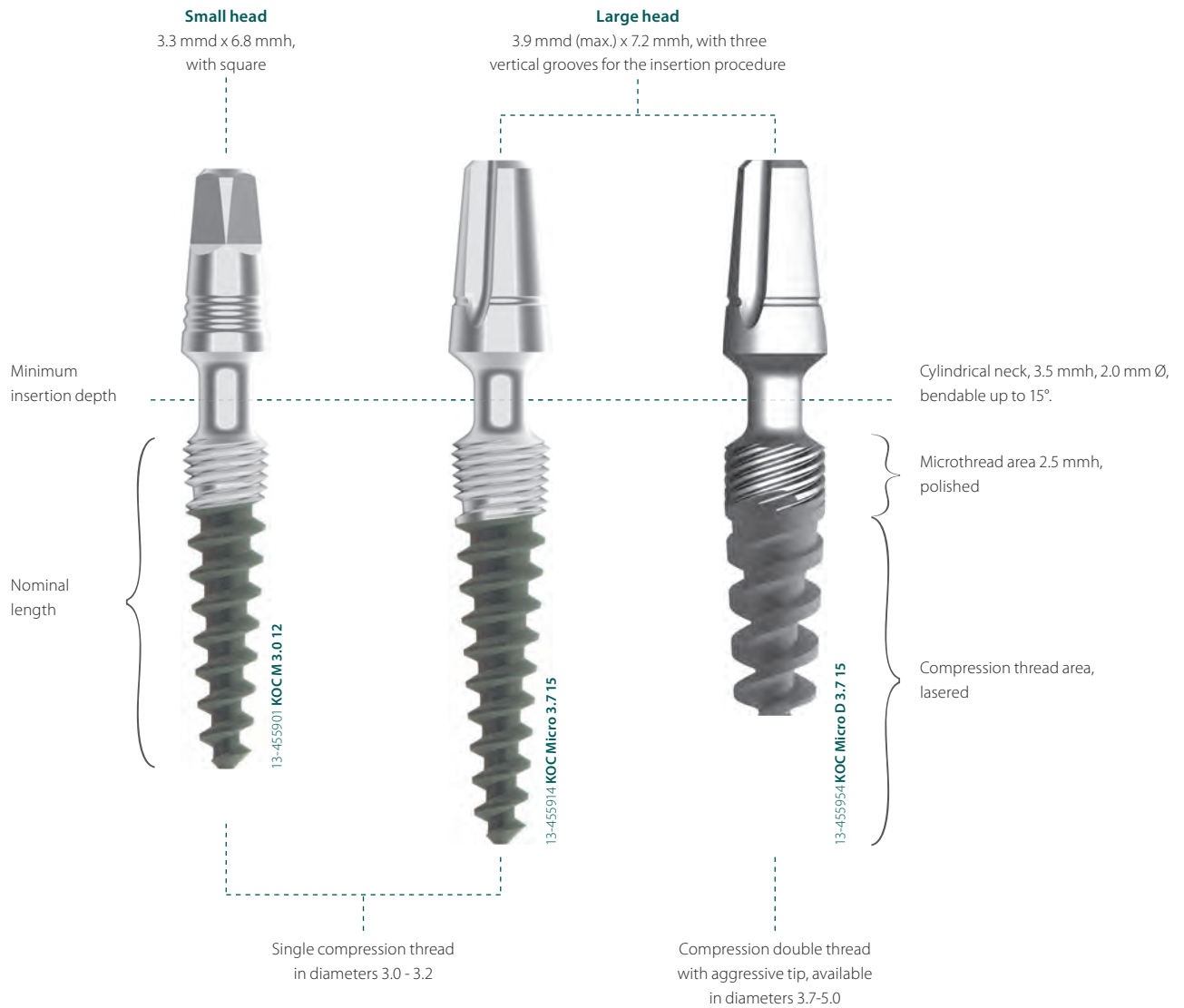
KOC® M & MICRO IMPLANTS



CORTICAL MILLING FOR KOC® MICRO

	Description		Code	REF	Price cat.
	C-Drill KM1 3.0 - 3.2	Cortical milling	C-Drill KM1	13-455300	E
	C-Drill KM2 3.7 - 4.1	Cortical milling	C-Drill KM2	13-455301	E
	C-Drill KM3 5.0	Cortical milling	C-Drill KM3	13-455302	E

MATERIAL

Ti6AL4V, also known as „Grade 5“, is the high-purity version of the conventional 6/4 Ti alloy, which is used for more than 50% of all metallic human implants. This material is the first choice for all applications which require high stability, corrosion resistance and mechanical strength. This is why today's most modern dental implant designs are made of this material. This titanium alloy is superior to the alternatively used pure titanium in terms of stability by more than 25%. Also regarding biocompatibility and the support of bone cell growth, this titanium alloy shows advantages compared to pure titanium.

FUNCTIONALITY

The one-piece **KOC® M / KOC® Micro** dental implant is preferably used in immediate loading. Unlike other compression screws, the polished neck has a cylindrical shape. Thus, the cortical is sealed, good retention is achieved in the cortical and the bone is protected against infections. At the same time, the endosseous implant part compresses the cancellous bone areas.

NOTE

The smooth microthread must be completely submerged below the bone level. The cylindrical neck must extend into the bone at least 1 mm deep. Therefore, the implant must be selected so that at least 1.5 mm more usable vertical bone is present than the nominal length of the implant.

Example For KOC Micro 3.7 15, 17 mm of usable vertical bone must be present. If in doubt, a shorter implant should be selected so as to ensure a sufficient insertion depth.

DRILLING PROCEDURE

The pilot hole is made with the drills of the **KOC®** system. Except in very dense mandibular bone, the pilot hole is usually sufficient with **BCD1** or **DOS1**.

INSERTION

The implant can be inserted most easily with the handgrip (REF 311431) and the adapter (REF 13-900 037). When using the ratchet RAT2, small or medium insertion tools are used. Max. torque is 80 Ncm.

THE IMPLANTS ARE SUPPLIED WITH TWO DIFFERENT HEAD SIZES

- **KOC® M** implants are supplied with a small head; they also fit in small individual tooth gaps.
- **KOC® Micro** implants are supplied with a large head. This head permits easy and speedy prosthetic restoration.

KOC® M IMPLANTS WITH SMALL ABUTMENT HEAD

KOC® M with small head for the anterior tooth region and tight gaps

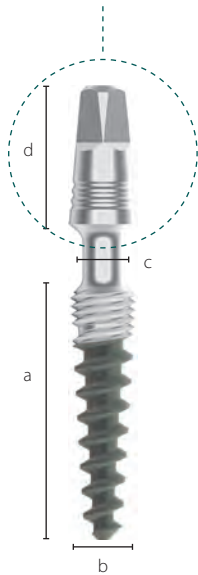

Description	Endosseous Ø	Length	Neck Ø	Drill *	REF	Price cat.
KOC M 3.0 10	3.0 mm	10 mm	2 mm	DOS 1 or BCD 1	13-456108	F
KOC M 3.0 12	3.0 mm	12 mm	2 mm		13-456109	F
KOC M 3.0 15	3.0 mm	15 mm	2 mm		13-456110	F
KOC M 3.2 12	3.2 mm	12 mm	2 mm		13-456111	F
KOC M 3.2 15	3.2 mm	15 mm	2 mm		13-456112	F
KOC M 3.7 6	3.7 mm	6 mm	2 mm	DOS 2 or BCD 2	13-456106	F
KOC M 3.7 8	3.7 mm	8 mm	2 mm		13-456107	F
KOC M 3.7 10	3.7 mm	10 mm	2 mm		13-456114	F
KOC M 3.7 12	3.7 mm	12 mm	2 mm		13-456115	F
KOC M 3.7 15	3.7 mm	15 mm	2 mm		13-456120	F

* In very hard bone, it may be additionally necessary to make a cylindrical hole with a twist Drill 2.5 mm to a depth of 2.5 mm.

a) endosseous length	6 - 15 mm
b) max endosseous Ø small head	3.7 mm
c) neck Ø	2.0 mm
d) Height of head	6.8 mm
Material	Ti6Al4V

KOC® M implants are delivered **incl. lab-set** consisting of REF 13-462111, 13-462029 and 13-462088



KOC® MICRO IMPLANTS WITH LARGE ABUTMENT HEAD

KOC® Micro with large head for all applications

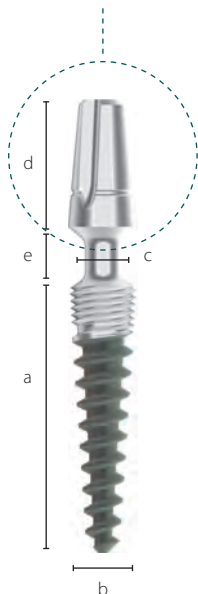

Description	Endosseous Ø	Length	Neck Ø	Drill *	REF	Price cat.
KOC Micro 3.7 6	3.7 mm	6 mm	2.0 mm	DOS 2 / BCD 2	13-455910	F
KOC Micro 3.7 8	3.7 mm	8 mm	2.0 mm	DOS 2 / BCD 2	13-455911	F
KOC Micro 3.7 10	3.7 mm	10 mm	2.0 mm	DOS 2 / BCD 2	13-455912	F
KOC Micro 3.7 12	3.7 mm	12 mm	2.0 mm	DOS 2 / BCD 2	13-455913	F
KOC Micro 3.7 15	3.7 mm	15 mm	2.0 mm	DOS 2 / BCD 2	13-455914	F
KOC Micro 4.1 8	4.1 mm	8 mm	2.0 mm	DOS 3 / BCD 3	13-455920	F
KOC Micro 4.1 10	4.1 mm	10 mm	2.0 mm	DOS 3 / BCD 3	13-455921	F
KOC Micro 4.1 12	4.1 mm	12 mm	2.0 mm	DOS 3 / BCD 3	13-455922	F
KOC Micro 4.1 15	4.1 mm	15 mm	2.0 mm	DOS 3 / BCD 3	13-455923	F
KOC Micro 5 10	5.0 mm	10 mm	2.0 mm	DOS 5	13-455925	F
KOC Micro 5 12	5.0 mm	12 mm	2.0 mm	DOS 5	13-455926	F

* In very hard bone, it may be additionally necessary to make a cylindrical hole with a twist Drill 2.5 mm to a depth of 2.5 mm.

a) endosseous length	6 - 15 mm
b) max endoss. Ø large head	3.9 mm
c) neck Ø	2.0 mm
d) height of head	7.2 mm
e) height of neck	3.5 mm
Material	Ti6Al4V

ACCESSORIES

Analogue IAB	REF 13-462106
Pack of 5	Price cat. B



KOC® Micro implants are delivered **incl. lab-set** consisting of REF 462111, 462136 and 462086



Impression post TSPA 5	REF 13-462030
Pack of 5	Price cat. B
Red impression caps and red analogue are round.	

KOC® MICRO D IMPLANTS WITH LARGE ABUTMENT HEAD



Description	Endosseous Ø	Length	Neck Ø	Drill *	REF	Price cat.
KOC Micro D 3.7 8	3.7 mm	8 mm	2.0 mm	DOS 2 / BCD 2	13-455951	G
KOC Micro D 3.7 15	3.7 mm	15 mm	2.0 mm	DOS 2 / BCD 2	13-455954	G
KOC Micro D 4.1 8	4.1 mm	8 mm	2.0 mm	DOS 3 / BCD 3	13-455957	G
KOC Micro D 4.1 10	4.1 mm	10 mm	2.0 mm	DOS 3 / BCD 3	13-455958	G
KOC Micro D 4.1 15	4.1 mm	15 mm	2.0 mm	DOS 3 / BCD 3	13-455960	G
KOC Micro D 5.0 12	5 mm	12 mm	2.0 mm	DOS 5	13-455964	G







* In very hard bone, it may be additionally necessary to make a cylindrical hole with a twist Drill 2.5 mm to a depth of 2.5 mm.

a) endosseous length	6 - 15 mm
b) max endoss. Ø large head	3.9 mm
c) neck Ø	2.0 mm
d) Height of head	7.2 mm
Material	Ti6Al4V

KOC® Micro D implants are delivered **incl. lab-set** consisting of REF 13-462111, 13-462136 and 13-462086



IMPRESSION TAKING AND LABORATORY ACCESSORIES

		Description	Unit	Material	Code	REF	Price cat.
FOR SMALL HEAD		Impression cap	Pack of 5	POM	TSPA 4	13-462029	B
		Castable abutment	Pack of 5		PO4	13-462088	B
		Double analogue for small and large head	Pack of 5	plastic	IA4/IAU	13-462111	B
		Double analogue		metal	IA4/IAU	13-462112	A
FOR LARGE HEAD		Impression post castable Internally edged	Pack of 5		PA X	13-462136	A
		Castable abutment	Pack of 5		POB	13-462086	B

PA X will be sold in the color orange, starting 01-2018

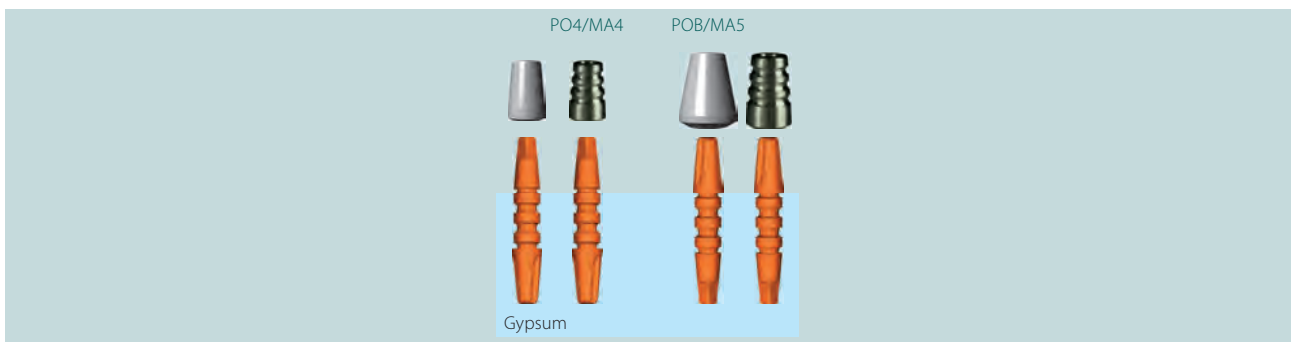

TITANIUM CROWN BASE

	Description	Material	Code	REF	Price cat.
	Titanium cap, radio opaque	Ti6Al4V, weldable	MA4	13-462090	B
	Titanium cap, radio opaque	Ti6Al4V, weldable	MA5	13-462093	B

SCANBODIES MATERIAL PEEK/POM



Description Scanbody-4
cylindrical

Systems KOC, BECES

REF 13-462054

Price cat. B (Pack of 5)



Description Scanbody-5
cylindrical

Systems KOC, BECES

REF 13-462055

Price cat. B (Pack of 5)



View from top



Description Scanbody-MU
cylindrical

Systems BECES® MU, KOC® MU, Hexacone® MU

REF 13-462056

Price cat. B (Pack of 5)



Description Flag-Scanbody **SCB4** for small head.
For intra-oral scan.

Systems KOC, BECES

REF 13-462071

Price cat. C (Pack of 5)



Description Flag-Scanbody **SCB5** for large head.
For intra-oral scan.

Systems KOC, BECES

REF 13-462072

Price cat. C (Pack of 5)



View from top



Description Flag-Scanbody **SCB MU** incl. screw
SFK MU (13-418164). For intra-oral scan.

Systems BECES® MU, KOC® MU, Hexacone® MU

REF 13-462073

Price cat. B (Pack of 1)

Please go to <http://simpladent-implant.com/en/stl> to download the corresponding STL files.

HEATLESS® DRILLS DOS FOR IMPLANTS WITH CONICAL CORE











Surgical steel, color-coded, depth-coded and autoclaveable. The drill is marked with laser depth markings.
Use between 3,000 and 5,000 rpm with good cooling and intermittent drill technique.
Due to the extremely high cutting performance, you can work without pressure.

-55%
heat

	Description	Colour	Max. working length	REF	Price cat.
	DOS 1	yellow	17 mm	13-455311	D
	DOS 2	black	17 mm	13-455312	D
	DOS 3	red	17 mm	13-455313	D
	DOS 4	blue	21 mm	13-455314	D
	DOS 5	green	17 mm	13-455315	D
	DOS 6	transparent	15 mm	13-455316	D

DOS 6 This drill is 2 mm shorter at the tip. It can therefore drill up to 2 mm deeper into hard bone than nominally indicated on the drill. Therefore, the conical bone cavity is only circularly extended in the crestal area without increasing the drilling depth.

INSTRUMENTS AND TOOLS

	Description	Length	Code	REF	Price cat.
	Insertion tool short, for large head. Use with RAT2 and TW2.	7 mm	IT2 S BECES	13-900038	E
	Insertion tool medium, for large head. Use with RAT2 and TW2.	19 mm	IT2 BECES	13-900030	E
	Insertion tool for large head. Use with angle piece.	23 mm	IT2W	13-900039	C
	Insertion tool long, for small head. Use with RAT2 and TW2.	20 mm	IT K	13-462320	C
	Insertion tool short, for small head. Use with RAT2 and TW2.	7 mm	ITS K	13-462322	C
	Insertion tool for small head. Use with angle piece.	23 mm	ITW K	13-462331	C
	Torque wrench 10 - 70 Ncm. It is recommended to have the torque ratchets recalibrated by us once a year.		TW2	13-425402	S
	Adapter for large head, use with handgrip.	70 mm	AHB	13-900037	F
	Adapter for small head, use with handgrip.	70 mm	AHK	13-462319	D
	Handgrip. For machine processing in the ultrasonic bath.	110 mm		13-311431	V

Heatless® Drill
DOS 1 REF 13-455311

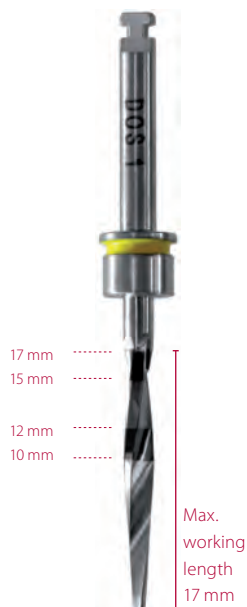

Heatless® Drill
DOS 2 REF 13-455312

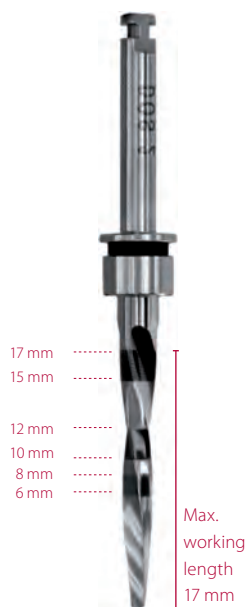

Heatless® Drill
DOS 3 REF 13-455313

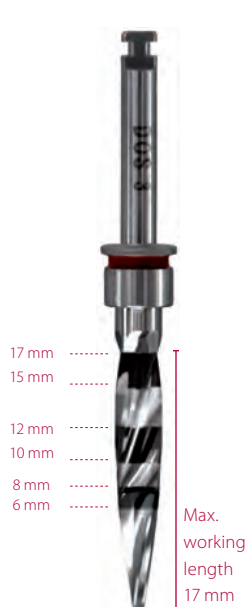

Heatless® Drill
DOS 4 REF 13-455314



Heatless® Drill
DOS 5 REF 13-455315

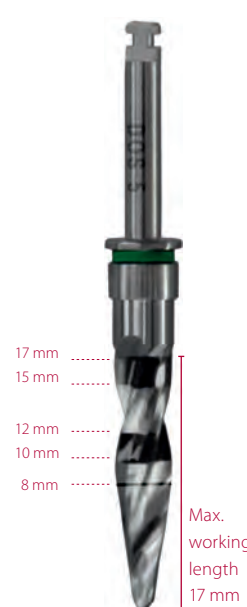

Twist Drill
ø 2.0 mm

Twist Drill 2.0/21
REF 13-90022



Twist Drill
ø 2.0 mm

Twist Drill 2.0/30
REF 13-90020



Twist Drill
ø 2.0 mm

Twist Drill 2.0/40
REF 13-90019

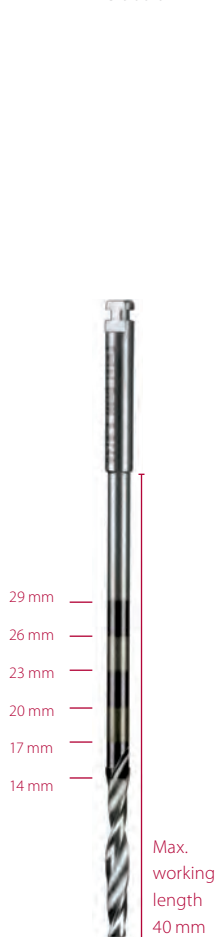

Twist Drill
für ZDI

Twist Drill 2.2 /50
REF 13-90021

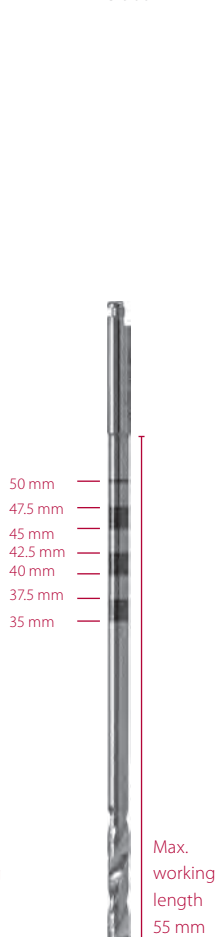

Twist Drill
für ZDI

Twist Drill 2.2 /55
REF 13-90023

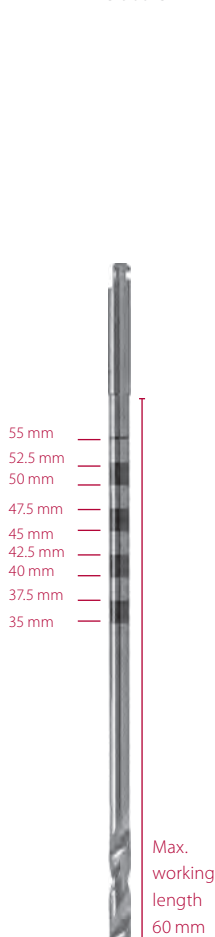

Twist Drill
für ZDI

Twist Drill 2.2
REF 13-310514

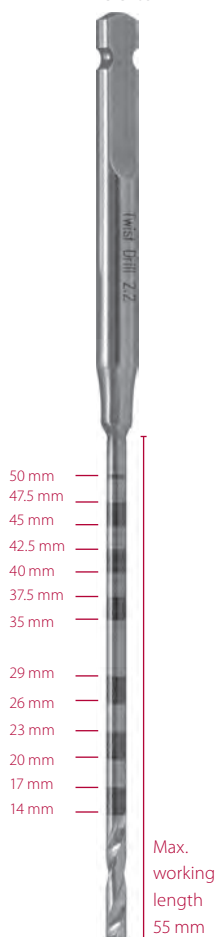

KOC® MINI IMPLANTS

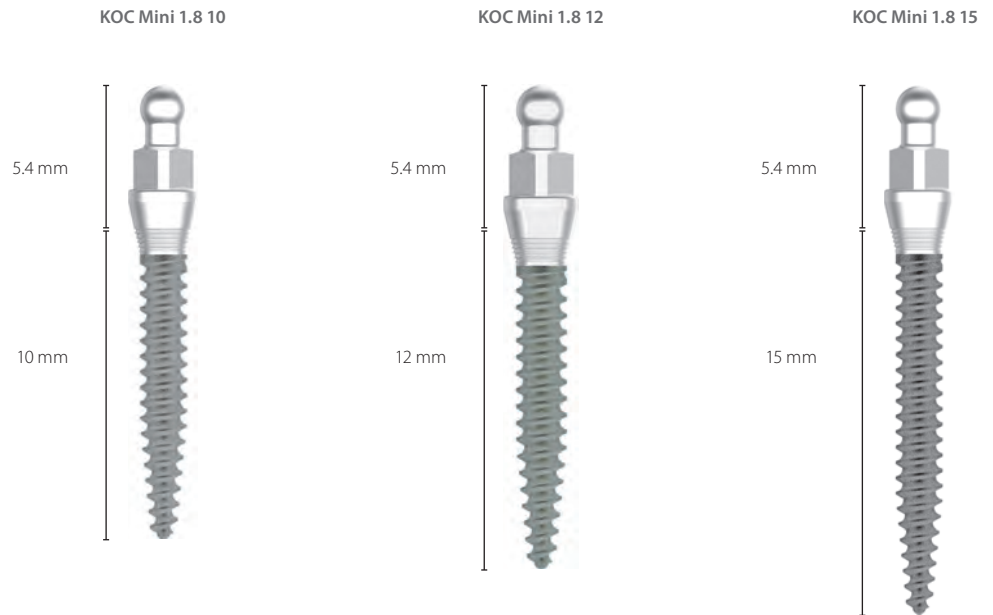

Description	Endosseous Ø	Endosseous length	Height above bone	Material	Max. insertion torque
KOC Mini 1.8 10	1.8 mm	10 mm	5.4 mm	Ti6AL4V	25 Ncm
KOC Mini 1.8 12	1.8 mm	12 mm	5.4 mm	Ti6AL4V	25 Ncm
KOC Mini 1.8 15	1.8 mm	15 mm	5.4 mm	Ti6AL4V	25 Ncm
KOC Mini 2.4 12	2.4 mm	12 mm	5.4 mm	Ti6AL4V	40 Ncm
KOC Mini 2.4 15	2.4 mm	15 mm	5.4 mm	Ti6AL4V	40 Ncm
KOC Mini 2.4 18	2.4 mm	18 mm	5.4 mm	Ti6AL4V	40 Ncm
KOC Mini 2.8 12	2.8 mm	12 mm	5.4 mm	Ti6AL4V	60 Ncm
KOC Mini 2.8 15	2.8 mm	15 mm	5.4 mm	Ti6AL4V	60 Ncm
KOC Mini 2.8 18	2.8 mm	18 mm	5.4 mm	Ti6AL4V	60 Ncm

SURGERY

1. Drilling and drill depth

KOC® Mini implants are inserted into the bone with self-tapping and with bone compression. As a rule, an undersized pilot hole is sufficient.

Recommended drill-speed: min. 3.000 Rpm, with sufficient cooling and intermittent drilling technique.

Note regarding hard bone: The torque must not exceed 45 Ncm during insertion. Should this be the case, the implant must be rotated out and the drilling depth extended to 2/3 of the implant length.



Drilling in hard bone:
1/2 of the endosseous
implant length

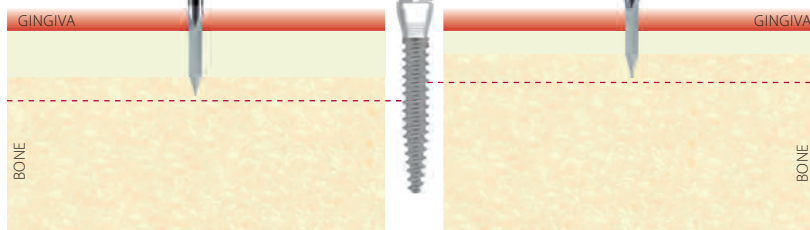

Drilling in soft bone:
1/3 of the endosseous
implant length

2. Removing the implant from the package

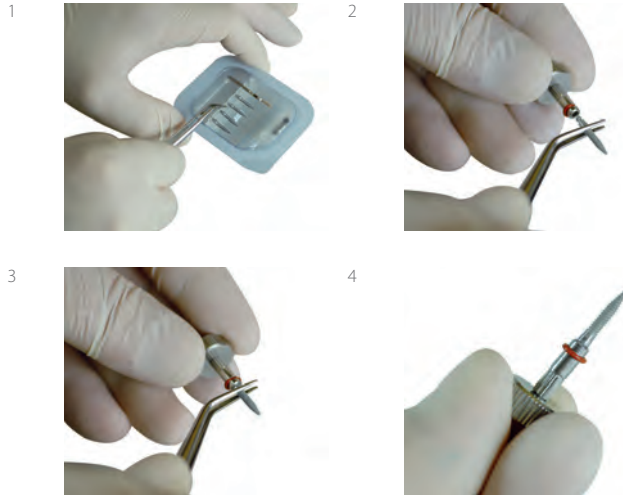

SAME PROCEDURE WITH REF13-462374 / REF 13-462376

3. insertion and placement



IT K
KOC® Mini
(short, 12 mm)
REF13-462376



IT K
KOC® Mini
(long, 20 mm)
REF13-462374



IT H KOC® Mini
for manual insertion
REF13-462375

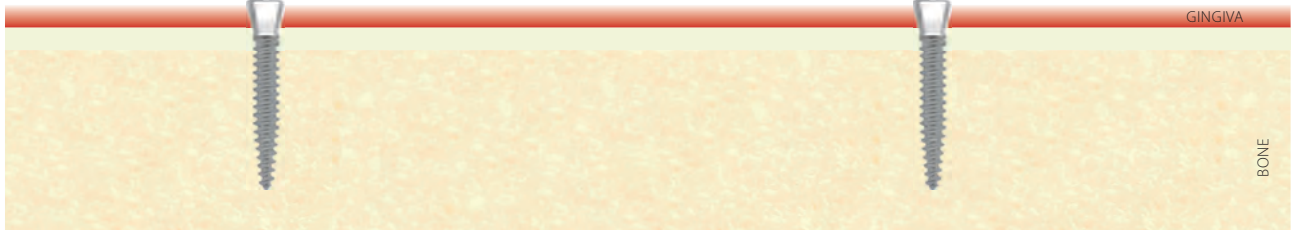

BONE

KOC® MINI SET 1.8 10

KOC® Mini 1.8 10 (pack of 4)
 Drill for KOC® Mini DS, ø 1.3 mm
 Sleeve and O-ring (set of 4)

REF	Price cat.
13-455050	Q

KOC® MINI SET 1.8 12

KOC® Mini 1.8 12 (pack of 4)
 Drill for KOC® Mini DS, ø 1.3 mm
 Sleeve and O-ring (set of 4)

REF	Price cat.
13-455051	Q

KOC® MINI SET 1.8 15

KOC® Mini 1.8 15 (pack of 4)
 Drill for KOC® Mini DS, ø 1.3 mm
 Sleeve and O-ring (set of 4)

REF	Price cat.
13-455052	Q

KOC® MINI SET 2.4 12

KOC® Mini 2.4 12 (pack of 4)
 Drill for KOC® Mini DS, ø 1.9 mm
 Sleeve and O-ring (set of 4)

REF	Price cat.
13-455053	Q

KOC® MINI SET 2.4 15

KOC® Mini 2.4 15 (pack of 4)
 Drill for KOC® Mini DS, ø 1.9 mm
 Sleeve and O-ring (set of 4)

REF	Price cat.
13-455054	Q

KOC® MINI SET 2.4 18

KOC® Mini 2.4 18 (pack of 4)
 Drill for KOC® Mini DS, ø 1.9 mm
 Sleeve and O-ring (set of 4)

REF	Price cat.
13-455055	Q

KOC® MINI SET 2.8 12

KOC® Mini 2.8 12 (pack of 4)
 Drill for KOC® Mini DS, ø 2.3 mm
 Sleeve and O-ring (set of 4)

REF	Price cat.
13-455056	Q

KOC® MINI SET 2.8 15

KOC® Mini 2.8 15 (pack of 4)
 Drill for KOC® Mini DS, ø 2.3 mm
 Sleeve and O-ring (set of 4)

REF	Price cat.
13-455057	Q







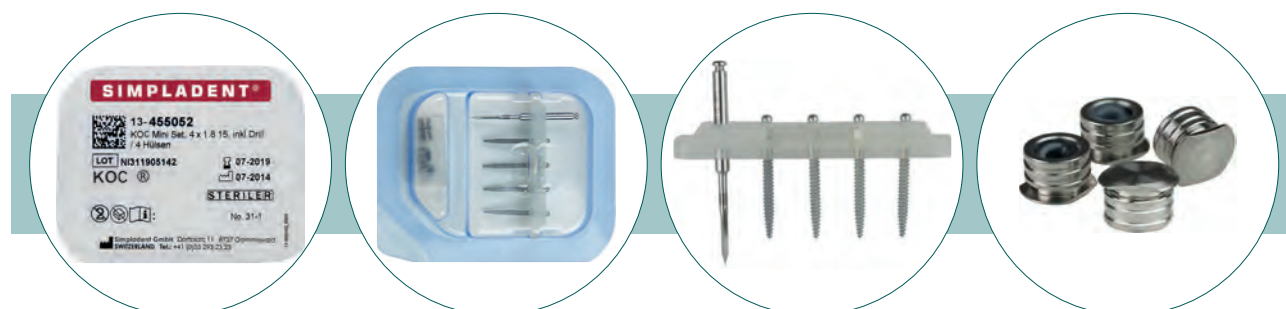





KOC® MINI SET 2.8 18

KOC® Mini 2.8 18 (pack of 4)
 Drill for KOC® Mini DS, ø 2.3 mm
 Sleeve and O-ring (set of 4)

REF	Price cat.
13-455058	Q



ACCESSORIES

	Description	Working length	Code	REF	Price cat.
	Insertion tool short, 12 mm		IT K KOC® Mini	13-462376	C
	Insertion tool long, 20 mm		IT K KOC® Mini	13-462374	C
	Insertion tool (2-piece) for manual insertion		IT H KOC® Mini	13-462375	D
	Torque wrench, 10 - 70 Ncm		TW2	13-425402	S
	Impression coping KOC® Mini Pack of 4			13-462117	A
	Analogue KOC® Mini Pack of 4			13-462116	A
	Sleeve KOC® Mini for polymerizing into the prosthesis, delivery with inserted O-ring			13-462113	B
	O-ring for sleeve REF 13-462113 for replacement. Pack of 4			13-462114	B
	Depth-measurement-probe for KOC® Mini			13-462115	A
	Drill for KOC® Mini, ø 1.3 mm	15 mm		13-455318	C
	Drill for KOC® Mini, ø 1.9 mm	18 mm		13-455319	C
	Drill for KOC® Mini, ø 2.3 mm	18.4 mm		13-455320	C

APPLICATIONS OF THE STRATEGIC IMPLANT® FOR ANCHORAGE IN THE UPPER AND LOWER JAW



BECES® implants can be used immediately in extraction sockets if the basal support is sufficient. The anti-rotation protection ensures immediate stability against unintentional unscrewing before prosthetic loading. The prosthesis should be inserted before the 3rd post-operative day. **BECES®** implants are made of strong, biocompatible titanium alloy Ti6Al4V ELI. **BECES®** implants are used typically for segments and circular bridges in an immediate splinting protocol. Their use is permitted only for authorized users.

BECES® EX implants provide a sharp and cutting central thread part, which engages in to the corticals of the extraction sockets. The apical compression thread provides perfect stability both in compressed spongy and in cortical bone. The coronal micro-thread seals the 1st cortical if the implant is used in healed bone areas. **BECES® EX** implants may be used both in extraction sockets and in healed bone areas. They are used for circular bridges and segments. Under adequate loading conditions and if enough implants are splinted, the treatment can be performed in an immediate load protocol. Due to their polished surface, **BECES® EX** implants are extremely resistant against bacterial colonialization and they avoid peri-implantitis.

For implant Ø from 3.5 to 4.6 mm, not less than ten implants should be used for the complete upper jaw.

For implant Ø from 3.5 to 4.6 mm, not less than eight implants should be used for the complete mandible.

The phase of adaptation and consolidation of the cortical bone in which these implants are anchored (2nd or 3rd cortical) must be considered to be 24 months after the insertion of the implants. So there is a significant difference to the healing times for implants that are used according to the method of "osseointegration", for which the healing times are assumed to be 3-6 months.

Nevertheless **BECES®** implants are designed to be used (solely by specially trained and authorized users) in immediate functional loading protocols.

FITTING AND CEMENTING OF PROSTHETICS

The lower border of the abutment head of the Strategic Implant® is (only) used as a margin to hold the transfer during impression-taking. Because the implant and the abutment head are both polished, the lower margin of the implant does not typically serve as a crown margin as we know it from teeth or conventional 2-stage implants. There are no medical or technical reasons why the crown margin (or the margin of the technical abutment) should reach the lower border of the abutment head.

It is important however that enough distance between the lower margin of the prosthetic workpiece and the gums (or the bone respectively) is left after cementation. We recommend to use only strong permanent cements (e.g. Fuji Plus, GC Corp.) and to have a vertical cementing surface/zone of at least 4 mm on the abutments. The abutment head may be shortened/adjusted vertically and/or laterally in order to achieve a good aesthetic result and to allow good phonetics.

Those surfaces on the abutment head which will provide retention for the cement must be roughened and cleaned before cementation. All other surfaces of the abutment head must remain fully polished.

The main aim of this step of the treatment is the incorporation of a prosthetic workpiece which is easily cleanable or which allows self-cleaning (on the lingual or palatal side) in function.

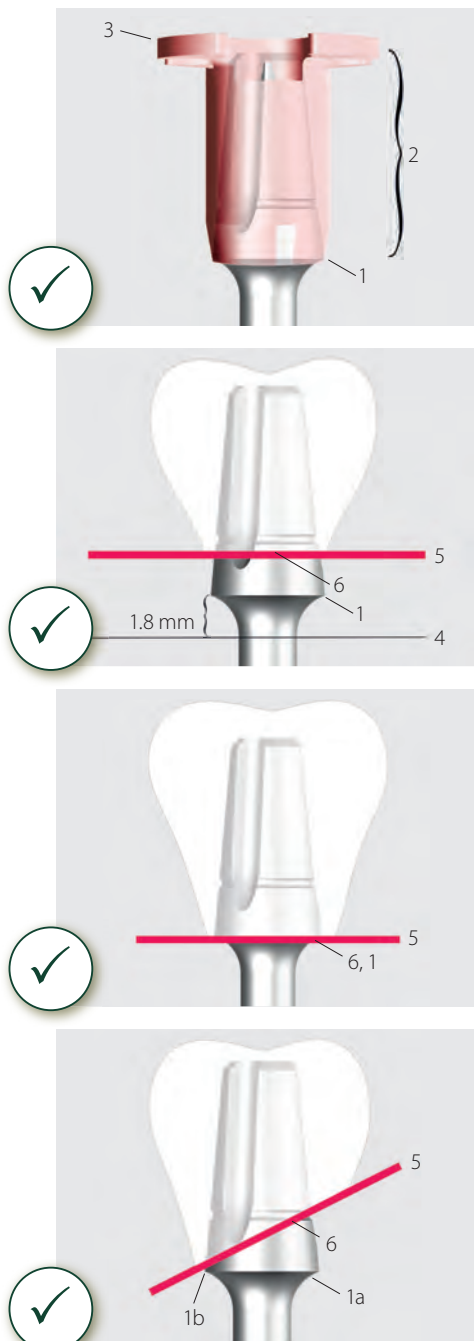

Fig. 1

The transfer cap (3) is positioned on the abutment head until the lower border of the abutment head (1) is reached. The transfer will sit firmly in this position. Then the impression is taken with silicone putty or heavy body silicone material. This allows the transfer of the implant position to the model.

Fig. 2

The implant head was placed approximately 1.8 mm above the bone level (4). The mucosa level (5) reaches higher than the lower border of the abutment head (1). The level of the crown margin (6) and the lower border of the abutment head (1) are in a distance to each other. This avoids retention of cements and debris in the submucosal area. This is a correct result. On the x-ray the crown will appear however as "too short", considering not applicable criteria from conventional dentistry.

Fig. 3

The crown margin (6) will be the same level as the lower border of the abutment head (1) if the abutment head sits on the mucosa line (5).

Fig. 4

If the abutment head is positioned on a mucosal slope, the lower border of the abutment head is on one side (1a) deeper in the mucosa than on the other side (1b). In such a case the crown margin (6) will also run oblique, in order to avoid submucosal position of parts of the crown. See the clinical example in Fig. 9. Also in this case the crown may appear as "too short" on the x-ray, considering not applicable criteria from conventional dentistry.

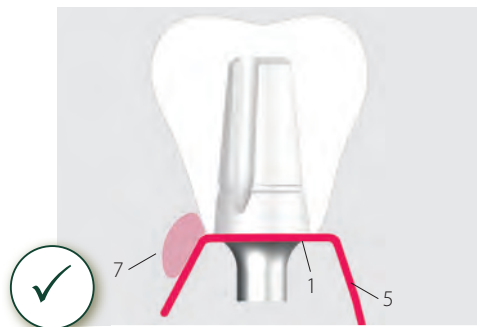
**Fig. 5**

For aesthetic reasons it may be necessary to create vestibular overhangig portions of the prosthetic workpiece (7).

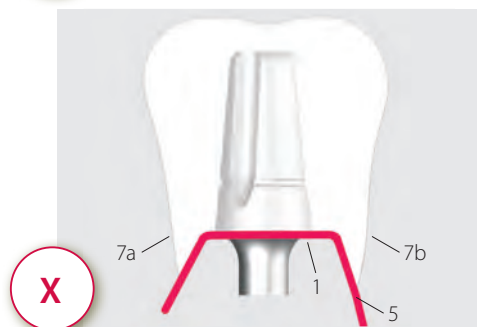
**Fig. 6**

It is not allowed to create such prosthetic overhangs (7a, 7b) on both sides of the prosthetic workpiece, because this would lead to a non-hygienic situation without the possibility of self cleaning. Food and debris will get stuck in the area of the mucosal penetration area of the implant and this will create an inflammation.

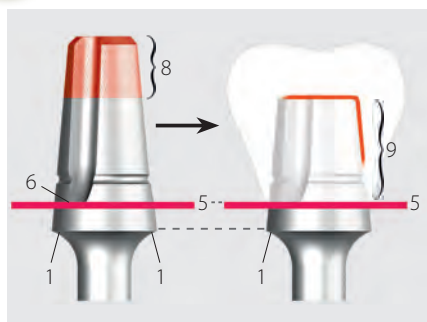
**Fig. 7**

If vertical height is missing, the top part of the abutment head may be shortened (region 8 is removed). At the same time it might be necessary to keep a distance between the lower margin of the abutment head (1) and the lower crown margin (6). Nevertheless the vertical cementation area (9) should be not less than 4 mm high.

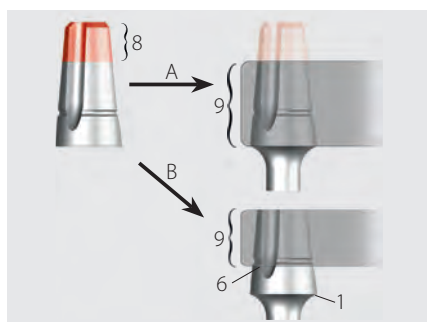
**Fig. 8**

If abutment heads are used as technical abutments, they are shortened after the final cementation of the prosthetic workpiece (region 8 is removed) and after the cement has fully set. This adjustment may be done at the first control appointment. They remain «open». The height of the cementing surface (9) should be not less than 4 mm. The lower margin of the crown does not necessarily coincide with the lower border of the abutment head.

**Fig. 9**

The implant crowns 43 and 44 have been shortened more than 3 mm on the lingual side and on the vestibular side an overhang has been modelled. The necessary height for cementation is given both on the vestibular and the lingual side on the abutment head.

CONCLUSION

The question if the prosthetic construction is properly fitted to the abutment of the Strategic Implant® depends on the spational relationship between the crown margin to the mucosa much more than on anything else. Relevant for any judgement about the length of the crown is the moment of the cementation.

Only for selected bridge materials and bridge designs, subgingival connection between implant abutment and prosthetics is possible. In such cases the final connection between the two components requires an open surgical cementation.

BECES® IMPLANTS 2.7 MMD WITH SMALL ABUTMENT HEAD

These implants are used for the following indications

- Supporting (additional) implants for cortical anchorages of bridges and crowns
- Creation of a three-point support for the cortical anchorage of dental prostheses

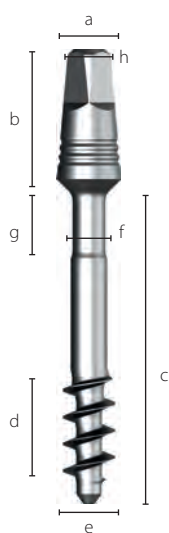

Description	c	d	e	g	Drill	REF	Price cat.
BECES 2.7 10	10	4.5	2.7	2.55	Twist Drill 1.8	13-900190	G
BECES 2.7 12	12	4.5	2.7	2.95	Twist Drill 1.8	13-900191	G
BECES 2.7 14	14	5.5	2.7	2.95	Twist Drill 1.8	13-900192	G
BECES 2.7 17	17	5.5	2.7	2.95	Twist Drill 1.8	13-900193	G
BECES 2.7 20	20	5.5	2.7	2.95	Twist Drill 1.8	13-900194	G
BECES 2.7 23	23	5.5	2.7	2.95	Twist Drill 1.8	13-900195	G
BECES 2.7 26	26	5.5	2.7	2.95	Twist Drill 1.8	13-900196	G
BECES 2.7 29	29	5.5	2.7	2.95	Twist Drill 1.8	13-900197	G
BECES 2.7 32	32	5.5	2.7	2.95	Twist Drill 1.8	13-900198	G

a) Max. abutment Ø	3.35 mm
b) Abutment height	6.8 mmh
c) Nominal length	10 - 32 mm
d) Length of apical thread	4.5 / 5.5 mm
e) Enossal Ø	max. 2.7 mm
f) Neck Ø in bending zone	1.9 mm
g) Length of bending zone	2.55 - 2.95 mm
h) Square AF (across flats)	1.9 mm
Tool	IT K, AHK



USE LIMITATIONS BECES 2.7 must not be used as an implant for single tooth replacement, however two or more BECES 2.7 may serve as such. If **only** BECES 2.7 is used in very thin jaws, the surgeon should try to insert at least eight, but better more (up to 12 implants) for this jaw. BECES 2.7 are considered additional dental implants and they are used with other BECES implants 3.5 mm - 12 mm in order to increase the stability of the implant-prosthetic system.

TWIST DRILL



Description	Ø	Max. working length	REF	Price cat.
Twist Drill 1.8/23	1.8 mm	23 mm	13-90024	D

ACCESSORIES

Analogue IAB		Impression post TSPA 5	
Pack of 5		Pack of 5	
REF 462106		REF 462030	
Price cat. B		Price cat. B	

The red impression cap and the red analogue are round (not secured against rotation).

BECES® IMPLANTS 3.0 MMD

BECES® IMPLANTS WITH SMALL ABUTMENT HEAD

These implants are used for the following indications

- Supporting (additional) implants for cortical anchorages of bridges and crowns
- Creation of a three-point support for the cortical anchorage of dental prostheses

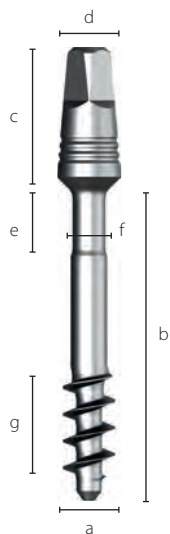

Description	a	b	e	g	Drill	REF	Price cat.
BECES 3.0 10	3.0	10	2.55	4.5	Twist Drill 1.8	13-900480	G
BECES 3.0 12	3.0	12	2.95	4.5	Twist Drill 1.8	13-900481	G
BECES 3.0 14	3.0	14	2.95	5.5	Twist Drill 1.8	13-900482	G
BECES 3.0 17	3.0	17	2.95	5.5	Twist Drill 1.8	13-900483	G
BECES 3.0 20	3.0	20	2.95	5.5	Twist Drill 1.8	13-900484	G
BECES 3.0 23	3.0	23	2.95	5.5	Twist Drill 1.8	13-900485	G
BECES 3.0 26	3.0	26	2.95	5.5	Twist Drill 1.8	13-900486	G
BECES 3.0 29	3.0	29	2.95	5.5	Twist Drill 1.8	13-900487	G
BECES 3.0 32	3.0	32	2.95	5.5	Twist Drill 1.8	13-900488	G

USE LIMITATIONS BECES 3.0 must not be used as an implant for single tooth replacement, however two or more BECES 3.0 may serve as such. If **only** BECES 3.0 is used in very thin jaws, the surgeon should try to insert at least eight, but better more (up to 12 implants) for this jaw. BECES 3.0 are considered additional dental implants and they are used with other BECES implants 3.5 mm - 12 mm in order to increase the stability of the implant-prosthetic system.

a) thread Ø	max. 3.0 mm
b) endosseous length	10 - 32 mm
c) abutment Height	6.8 mm
d) max. abutment Ø	3.35 mm
e) length of bending zone	3.0 mm
f) shaft diameter in the bending zone	1.9 mm
g) length of the apical thread	4.5 / 5.5 mm (depending on the endosseous implant length)
Tool	IT K, AHK

TWIST DRILL



Description	Ø	Max. working length	REF	Price cat.
Twist Drill 1.8/23	1.8 mm	23 mm	13-90024	D

PATHFINDER DRILLS

Conical 3-edge drill as initial drill, ideally suited for all crestal implant systems. The drill also passes between narrow cortical areas without pressure.



Description	Colour	Max. working length	REF	Price cat.
BCDX 1	yellow	15 mm	13-900243	C

BECES® IMPLANTS WITH SMALL ABUTMENT HEAD

BECES® implants 3.5 mmd - 12 mmd

For anchorage in the 1st, 2nd and if necessary 3rd cortical, for the cortical anchorage of dental prostheses. **BECES®** implants can be used in sockets for a given indication immediately after extraction and loaded immediately in many cases. Mechanically smoothed surface in all areas. The abutment head is identical to the head of **KOC®** implants and the **TSD4** abutment. Self-tapping thread with endosseous anti-rotation protection. Conditionally suitable for individual tooth prostheses.

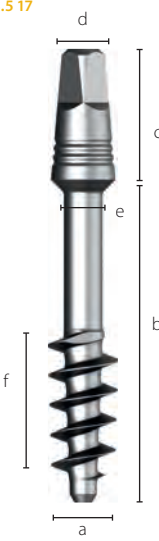
	Description	a	b	f	REF	Price cat.
	BECES 3.5 10	3.5	10	5.5	13-900208	G
	BECES 3.5 12	3.5	12	5.5	13-900226	G
	BECES 3.5 14	3.5	14	7.5	13-900210	G
	BECES 3.5 17	3.5	17	7.5	13-900211	G
	BECES 3.5 20	3.5	20	7.5	13-900212	G
	BECES 3.5 23	3.5	23	7.5	13-900213	G
	BECES 3.5 26	3.5	26	7.5	13-900214	G
	BECES 3.5 29	3.5	29	7.5	13-900215	G
	BECES 3.5 32	3.5	32	7.5	13-900216	G
	BECES 3.5 35	3.5	35	7.5	13-900217	G
	BECES 3.5 38	3.5	38	7.5	13-900218	G
	BECES 4.5 10	4.5	10	7.5	13-900238	G
	BECES 4.5 12	4.5	12	7.5	13-900239	G
	BECES 4.5 14	4.5	14	7.5	13-900220	G
	BECES 4.5 17	4.5	17	7.5	13-900221	G
	BECES 4.5 20	4.5	20	7.5	13-900222	G
	BECES 4.5 23	4.5	23	7.5	13-900223	G
	BECES 4.5 26	4.5	26	7.5	13-900224	G
	BECES 4.5 29	4.5	29	7.5	13-900225	G

Insertion tools: IT KOC, ITX KOC, ITS KOC, Adapter AHK

a) max. thread Ø	3.5 - 4.5 mm
b) nominal length	10 - 38 mm
c) height abutment	6.8 mm
d) max. abutment Ø	3.35 mm
e) max. crestal Ø of shaft	2.0 mm
f) length of thread	5.5 - 7.5 mm
Square key width	1.9 mm

Max. insertion torque 80 Ncm

BECES® implants are delivered **incl. lab-set** consisting of REF 13-462111, 13-462029 and 13-462088



FIELD OF APPLICATION

Endosseous dental implant for 2nd cortical anchorage. For full upper jaws we recommend the usage of 10 - 12 or more implants, for full lower jaws the usage of 8 - 10 implants or more. For unilateral segments we recommend to use 4 - 6 implants.

BECES® IMPLANTS WITH LARGE ABUTMENT HEAD

	Description	a	b	f	REF	Price cat.	
BECES 3.6 17	BECES 3.6 10	3.6	10	5.5	13-900285	H	
	BECES 3.6 12	3.6	12	5.5	13-900284	H	
	BECES 3.6 14	3.6	14	7.5	13-900286	H	
	BECES 3.6 17	3.6	17	7.5	13-900287	H	
	BECES 3.6 20	3.6	20	7.5	13-900288	H	
	BECES 3.6 23	3.6	23	7.5	13-900289	H	
	BECES 3.6 26	3.6	26	7.5	13-900290	H	
	BECES 3.6 29	3.6	29	7.5	13-900291	H	
	BECES 4.6 8	BECES 4.6 8	4.6	8	5.5	13-900299	H
		BECES 4.6 10	4.6	10	5.5	13-900292	H
BECES 4.6 12		4.6	12	5.5	13-900300	H	
BECES 4.6 14		4.6	14	7.5	13-900293	H	
BECES 4.6 17		4.6	17	7.5	13-900294	H	
BECES 4.6 20		4.6	20	7.5	13-900295	H	
BECES 4.6 23		4.6	23	7.5	13-900296	H	
BECES 4.6 26		4.6	26	7.5	13-900297	H	
BECES 4.6 29		4.6	29	7.5	13-900298	H	
BECES 4.6 14		BECES 5.5 14	BECES 5.5 8	5.5	8	5.5	13-900255
BECES 5.5 14	BECES 5.5 10	5.5	10	5.5	13-900281	K	
	BECES 5.5 12	5.5	12	6.0	13-900250	K	
	BECES 5.5 14	5.5	14	6.0	13-900251	K	
	BECES 5.5 17	5.5	17	6.0	13-900252	K	
	BECES 5.5 20	5.5	20	6.0	13-900253	K	
	BECES 5.5 23	5.5	23	6.0	13-900265	K	
	BECES 5.5 26	5.5	26	6.0	13-900266	K	
	BECES 5.5 29	5.5	29	6.0	13-900267	K	

Insertion tools: IT2 BECES, IT2 S BECES, Adapter AHB

a) max. thread Ø	3.6 - 5.5 mm
b) nominal length	8 - 29 mm
c) length abutment	7.2 mm
d) abutment Ø	3.9 mm
e) max. crestal Ø of shaft	2.0 mm
f) length of thread	5.5 - 7.5 mm

BECES® Implants with large head are delivered **incl. lab-set** consisting of REF 13-462111, 13-462136 and 13-462086



FIELD OF APPLICATION BECES 3.6 MMD - 5.5 MMD

Endosseous dental implant for 2nd/3rd cortical anchorage. We recommend for full upper jaws the usage of 10-12 implants or more, for full lower jaws the usage of 8-10 implants or more. For unilateral segments we recommend to use 4-6 implants.

Max. insertion torque 80 Ncm

BECES® IMPLANTS WITH LARGE ABUTMENT HEAD

BECES 12 12

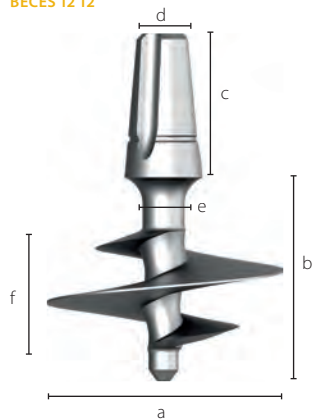

BECES 7 12 BECES 9 14 BECES 10.5 14



a) thread Ø	7 - 12 mm
b) endosseous length	8 - 20 mm
c) length abutment	7.2 mm
d) abutment Ø	3.9 mm
e) max. crestal Ø of shaft	2.0, 2.1 mm
f) length of thread	5.5 - 6.5 mm

Max. insertion torque 80 Ncm

Description	a	b	e	f	REF	Price cat.
BECES 7.0 8	7	8	2.0	5.5	13-900258	K
BECES 7.0 10	7	10	2.0	5.5	13-900282	K
BECES 7.0 12	7	12	2.0	5.5	13-900260	K
BECES 7.0 14	7	14	2.0	5.5	13-900261	K
BECES 7.0 17	7	17	2.0	5.5	13-900262	K
BECES 7.0 20	7	20	2.0	5.5	13-900263	K
BECES 9.0 8	9	8	2.1	5.5	13-900269	M
BECES 9.0 10	9	10	2.1	5.5	13-900270	M
BECES 9.0 12	9	12	2.1	5.5	13-900274	M
BECES 9.0 14	9	14	2.1	5.5	13-900271	M
BECES 10.5 10	10.5	10	2.1	6.5	13-900276	M
BECES 10.5 12	10.5	12	2.1	6.5	13-900277	M
BECES 10.5 14	10.5	14	2.1	6.5	13-900278	M
BECES 10.5 17	10.5	17	2.1	6.5	13-900280	M
BECES 12.0 8	12	8	2.1	5.5	13-900279	O
BECES 12.0 10	12	10	2.1	5.5	13-900272	O
BECES 12.0 12	12	12	2.1	6.5	13-900275	O
BECES 12.0 14	12	14	2.1	6.5	13-900273	O



Insertion tools: IT2 BECES, IT2 S BECES, Adapter AHB

BECES® Implants with large head are delivered **incl. lab-set** consisting of REF 13-462111, 13-462136 and 13-462086

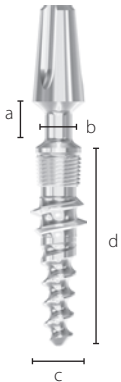

BECES® EX IMPLANTS

BECES® EX implants provide a sharp and cutting crestal thread, which engages in to the corticals of the extraction sockets. The apical compression thread provides perfect stability both in compressed spongy and in cortical bone. **BECES® EX** implants may be used both in extraction sockets and in healed bone areals. They are used for circular bridges and segments with at least three implants. Under adequate loading conditions and if enough implants are splinted, the treatment can be performed in an immediate load protocol. Due to their polished surface, **BECES® EX** implants are extremely resistant against bacterial colonialization and peri-implantitis. Material Ti6AL4V ELI, triple thread.

	Description	Max. endosseous Ø mm	Endosseous length	REF	Price cat.
BECES EX 3.5 + 15 	BECES EX 3.5 + 12	3.5	12	13-420150	K
	BECES EX 3.5 + 15	3.5	15	13-420151	K
	BECES EX 3.5 + 17	3.5	17	13-420152	K
	BECES EX 3.5 + 19	3.5	19	13-420153	K
	BECES EX 3.5 + 21	3.5	21	13-420154	K
	BECES EX 3.5 + 23	3.5	23	13-420155	K
	BECES EX 3.5 + 26	3.5	26	13-420156	K
	BECES EX 3.5 + 29	3.5	29	13-420157	K
BECES EX 4.1 + 15 	BECES EX 4.1 + 12	4.1	12	13-420160	K
	BECES EX 4.1 + 15	4.1	15	13-420161	K
	BECES EX 4.1 + 17	4.1	17	13-420162	K
	BECES EX 4.1 + 19	4.1	19	13-420163	K
	BECES EX 4.1 + 21	4.1	21	13-420164	K
	BECES EX 4.1 + 23	4.1	23	13-420165	K

a) Neck height	3.8 mm
b) Neck diameter	2 mm (bendable up to 15°)
c) Max. endosseous Ø	3.5 / 4.1 mm
d) Endosseous length	12 - 23 mm
Abutment	3.9 w x 7.2 h (mm)

STRATEGIC IMPLANT® WITH SMALL ABUTMENT HEAD

STRATEGIC IMPLANT® 3.5 mmd - 12 mmd

For anchorage in the 1st, 2nd and if necessary 3rd cortical, for the cortical anchorage of dental prostheses. **Strategic Implant®** can be used in sockets for a given indication immediately after extraction and loaded immediately in many cases. Mechanically smoothed surface in all areas. The abutment head is identical to the head of **KOC®** implants and the **TSD4** abutment. Self-tapping thread with endosseous anti-rotation protection. Conditionally suitable for individual tooth prostheses.

Strategic Implant® 3.5 17

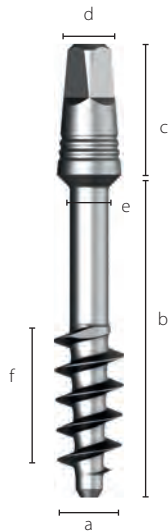

Description	a	b	f	REF	Price cat.
Strategic Implant® 3.5 10	3.5	10	5.5	14-900208	G
Strategic Implant® 3.5 12	3.5	12	5.5	14-900226	G
Strategic Implant® 3.5 14	3.5	14	7.5	14-900210	G
Strategic Implant® 3.5 17	3.5	17	7.5	14-900211	G
Strategic Implant® 3.5 20	3.5	20	7.5	14-900212	G
Strategic Implant® 3.5 23	3.5	23	7.5	14-900213	G
Strategic Implant® 3.5 26	3.5	26	7.5	14-900214	G
Strategic Implant® 3.5 29	3.5	29	7.5	14-900215	G
Strategic Implant® 3.5 32	3.5	32	7.5	14-900216	G
Strategic Implant® 3.5 35	3.5	35	7.5	14-900217	G
Strategic Implant® 3.5 38	3.5	38	7.5	14-900218	G
Strategic Implant® 4.5 10	4.5	10	7.5	14-900238	G
Strategic Implant® 4.5 12	4.5	12	7.5	14-900239	G
Strategic Implant® 4.5 14	4.5	14	7.5	14-900220	G
Strategic Implant® 4.5 17	4.5	17	7.5	14-900221	G
Strategic Implant® 4.5 20	4.5	20	7.5	14-900222	G
Strategic Implant® 4.5 23	4.5	23	7.5	14-900223	G
Strategic Implant® 4.5 26	4.5	26	7.5	14-900224	G
Strategic Implant® 4.5 29	4.5	29	7.5	14-900225	G

Insertion tools: IT KOC, ITX KOC, ITS KOC, Adapter AHK

a) max. thread Ø	3.5 - 4.5 mm
b) nominal length	10 - 38 mm
c) height abutment	6.8 mm
d) max. abutment Ø	3.35 mm
e) max. crestal Ø of shaft	2.0 mm
f) length of thread	5.5 - 7.5 mm
Square key width	1.9 mm

Max. insertion torque 80 Ncm

Strategic Implant® are delivered
incl. lab-set consisting of REF 13-462111,
13-462029 and 13-462088



FIELD OF APPLICATION

Endosseous dental implant for 2nd cortical anchorage. For full upper jaws we recommend the usage of 10 - 12 or more implants, for full lower jaws the usage of 8 - 10 implants or more. For unilateral segments we recommend to use 4 - 6 implants.

STRATEGIC IMPLANT® IMPLANTS WITH LARGE ABUTMENT HEAD

Strategic Implant® 3.6 17

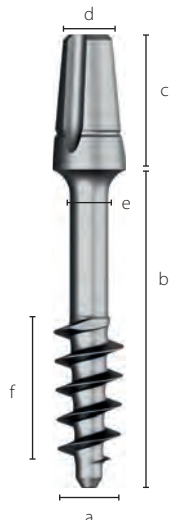

Description

Strategic Implant® 3.6 10
Strategic Implant® 3.6 12
Strategic Implant® 3.6 14
Strategic Implant® 3.6 17
Strategic Implant® 3.6 20
Strategic Implant® 3.6 23
Strategic Implant® 3.6 26
Strategic Implant® 3.6 29
Strategic Implant® 4.6 8
Strategic Implant® 4.6 10
Strategic Implant® 4.6 12
Strategic Implant® 4.6 14
Strategic Implant® 4.6 17
Strategic Implant® 4.6 20
Strategic Implant® 4.6 23
Strategic Implant® 4.6 26
Strategic Implant® 4.6 29
Strategic Implant® 5.5 8
Strategic Implant® 5.5 10
Strategic Implant® 5.5 12
Strategic Implant® 5.5 14
Strategic Implant® 5.5 17
Strategic Implant® 5.5 20
Strategic Implant® 5.5 23
Strategic Implant® 5.5 26
Strategic Implant® 5.5 29

a	b	f	REF	Price cat.
3.6	10	5.5	14-900285	H
3.6	12	5.5	14-900284	H
3.6	14	7.5	14-900286	H
3.6	17	7.5	14-900287	H
3.6	20	7.5	14-900288	H
3.6	23	7.5	14-900289	H
3.6	26	7.5	14-900290	H
3.6	29	7.5	14-900291	H
4.6	8	5.5	14-900299	H
4.6	10	5.5	14-900292	H
4.6	12	5.5	14-900300	H
4.6	14	7.5	14-900293	H
4.6	17	7.5	14-900294	H
4.6	20	7.5	14-900295	H
4.6	23	7.5	14-900296	H
4.6	26	7.5	14-900297	H
4.6	29	7.5	14-900298	H
5.5	8	5.5	14-900255	K
5.5	10	5.5	14-900281	K
5.5	12	6.0	14-900250	K
5.5	14	6.0	14-900251	K
5.5	17	6.0	14-900252	K
5.5	20	6.0	14-900253	K
5.5	23	6.0	14-900265	K
5.5	26	6.0	14-900266	K
5.5	29	6.0	14-900267	K

Strategic Implant® 4.6 14 5.5 14



Insertion tools: IT2 BECES, IT2 S BECES, Adapter AHB

a) max. thread Ø	3.6 - 5.5 mm
b) nominal length	8 - 29 mm
c) length abutment	7.2 mm
d) abutment Ø	3.9 mm
e) max. crestal Ø of shaft	2.0 mm
f) length of thread	5.5 - 7.5 mm

Strategic Implant® with large head are delivered **incl. lab-set** consisting of REF 13-462111, 13-462136 and 13-462086



ACCESSORIES

Analogue IAB

REF 13-462106

Pack of 5

Price cat. B



Impression post TSPA 5 REF 13-462030

Pack of 5

Price cat. B

Red impression caps and red analogue are round.

FIELD OF APPLICATION Strategic Implant® 3.6 MMD - 5.5 MMD

Endosseous dental implant for 2nd/3rd cortical anchorage. We recommend for full upper jaws the usage of 10-12 implants or more, for full lower jaws the usage of 8-10 implants or more. For unilateral segments we recommend to use 4-6 implants.

Max. insertion torque 80 Ncm

STRATEGIC IMPLANT® IMPLANTS WITH LARGE ABUTMENT HEAD

Strategic Implant® 12 12

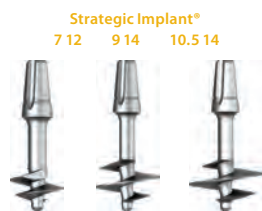
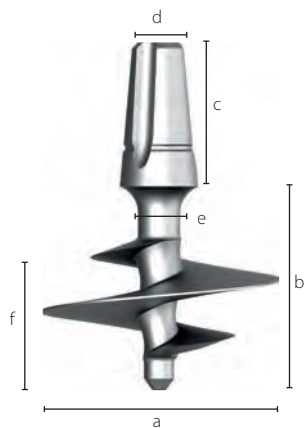

Description	a	b	e	f	REF	Price cat.
Strategic Implant® 7.0 8	7	8	2.0	5.5	14-900258	K
Strategic Implant® 7.0 10	7	10	2.0	5.5	14-900282	K
Strategic Implant® 7.0 12	7	12	2.0	5.5	14-900260	K
Strategic Implant® 7.0 14	7	14	2.0	5.5	14-900261	K
Strategic Implant® 7.0 17	7	17	2.0	5.5	14-900262	K
Strategic Implant® 7.0 20	7	20	2.0	5.5	14-900263	K
Strategic Implant® 9.0 8	9	8	2.1	5.5	14-900269	M
Strategic Implant® 9.0 10	9	10	2.1	5.5	14-900270	M
Strategic Implant® 9.0 12	9	12	2.1	5.5	14-900274	M
Strategic Implant® 9.0 14	9	14	2.1	5.5	14-900271	M
Strategic Implant® 10.5 10	10.5	10	2.1	6.5	14-900276	M
Strategic Implant® 10.5 12	10.5	12	2.1	6.5	14-900277	M
Strategic Implant® 10.5 14	10.5	14	2.1	6.5	14-900278	M
Strategic Implant® 10.5 17	10.5	17	2.1	6.5	14-900280	M
Strategic Implant® 12.0 8	12	8	2.1	5.5	14-900279	O
Strategic Implant® 12.0 10	12	10	2.1	5.5	14-900272	O
Strategic Implant® 12.0 12	12	12	2.1	6.5	14-900275	O
Strategic Implant® 12.0 14	12	14	2.1	6.5	14-900273	O

Insertion tools: IT2 BECES, IT2 S BECES, Adapter AHB

a) thread Ø	7 - 12 mm
b) endosseous length	8 - 20 mm
c) length abutment	7.2 mm
d) abutment Ø	3.9 mm
e) max. crestal Ø of shaft	2.0, 2.1 mm
f) length of thread	5.5 - 6.5 mm

Max. insertion torque 80 Ncm

Strategic Implant® with large head are delivered **incl. lab-set** consisting of REF 13-462111, 13-462136 and 13-462086











ACCESSORIES

Analogue IAB	REF 13-462106		Impression post TSPA 5	REF 13-462030
Pack of 5	Price cat. B		Pack of 5	Price cat. B

Red impression caps and red analogue are round.

IMPRESSION TAKING AND LABORATORY ACCESSORIES FOR BECES® AND KOC® IMPLANTS

	Description	Unit	Code	REF	Price cat.
ALTERNATIVE	 Impression post castable, POM For small head Internally round	Pack of 5	TSPA 4	13-462029	B
	 Impression post castable, POM For small head Internally round	Pack of 5	TSPA 4	13-462027	B
	 Impression post castable, POM For large head Internally round	Pack of 5	TSPA 5	13-462030	B
	 Impression post castable Internally edged	Pack of 5	PA X	13-462136	B
	Double analogue, metal	1 piece	IA4/IAU	13-462112	A
	Double analogue, plastic	Pack of 5	IA4/IAU	13-462111	B
	Castable abutment and base for provisionals For small head 7 mm high, white, internally round	Pack of 5	PO4	13-462088	B
	Castable abutment For large head Internally round	Pack of 5	POB	13-462086	B

GUIDE JACKET

	Description	Unit	Material	REF	Price cat.
	BFH 2.0 guide jacket 2.0 mmd	Pack of 5	Ti6Al4V	13-425410	B
	BFH 2.5 guide jacket 2.5 mmd	Pack of 5	Ti6Al4V	13-425411	B
	a) Length b) Height of step c) Max. Ø top d) Nominal Ø e) Ø of drilling in the drill template	5 mm 0.7 mm 3.7 / 4 mm 3 / 3.35 mm 2.05 / 2.55 mm			



Model with residual teeth for the fabrication of a drill guide for creating cavities for fixating the later drill guide for implant cavities.

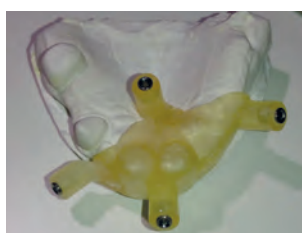

Drill guide for creating cavities for later fixation of the surgical drill guide.



Surgical drill guide for safe BECES® placement. The drill sleeves are designed for 2.0 mm Twist drills.

HANDGRIP SELF LOCKING

For machine reprocessing, cannot be dismantled. Clean in an ultrasonic bath at 45° with an alkaline cleaning agent. For adapter, self-locking. Please note the cleaning instructions on www.implant.com/en/downloads



Length
110 mm
REF
13-311431
Price cat.
V

DRILLS

Description	Length	Code	REF	Price cat.
Adapter	100 mm	BCD 1 Adapter	13-310511 F	
Twist Drill	110 mm	Twist Drill 2.0	13-310512 F	

INSERTION TOOLS

Description	Length	Code	REF	Price cat.
For KOC®, KOC® B, KDS, BECES 3.5, BECES 4.5	70 mm	Adapter AHK	13-462319 D	
For KOC® X, KOC® TX, KOC® Plus, BECES 3.6, BECES 4.6, ab > 5.5	70 mm	Adapter AHB	13-900037 F	

USE OF THE HANDGRIP

ON THE EXAMPLE OF A LARGE ABUTMENT HEAD BECES® IMPLANT



1. Use of the handgrip



2. Break off and implant immediately in the designated place



HANDGRIP TRAY

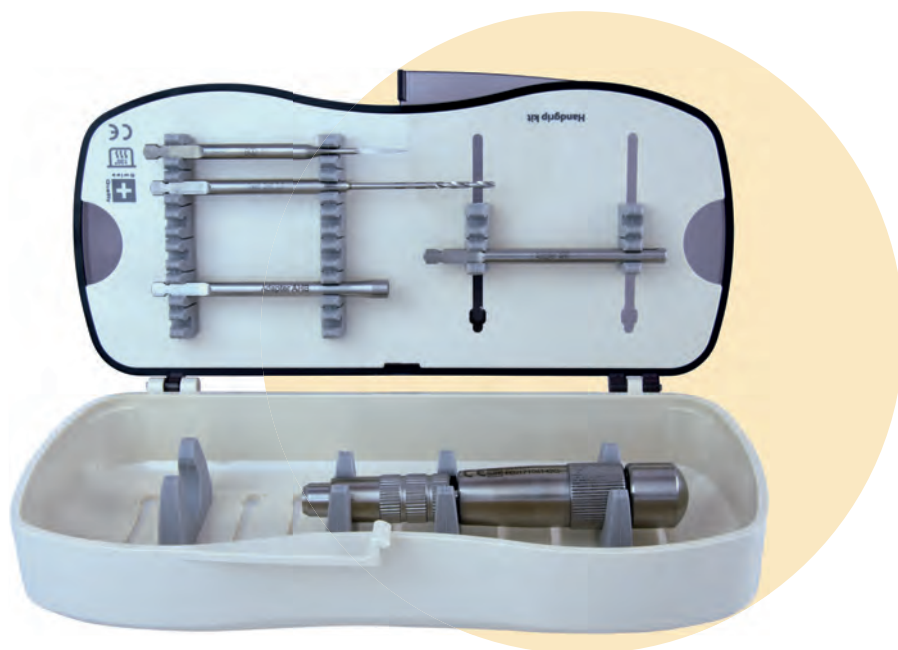

Size of closed tray
W 195 mm **D** 90 mm **H** 45 mm
 For all autoclaves

Description

BCD 1 Adapter
 Twist Drill 2.0
 Adapter AHK
 Adapter AHB
 Handgrip

Length

100 mm
 110 mm
 70 mm
 70 mm
 110 mm

REF

13-310511
 13-310512
 13-462319
 13-900037
 13-311431

Price €







Handgrip tray w/o content
Handgrip tray with content

13-60043 upon request
 13-S60043 upon request

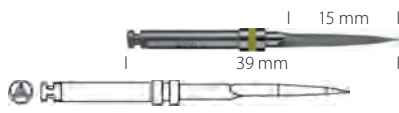



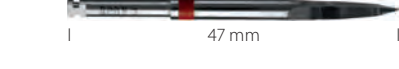

Please read our detailed instructions for cleaning and re-sterilization of surgical instruments on
<https://implant.com/en/downloads>

PATHFINDER DRILLS

Conical 3-edge drill as initial drill, ideally suited for all crestal implant systems. The drill also passes between narrow cortical areas without pressure.

	Description	Colour	Max. working length	REF	Price cat.
	BCD 1	yellow	15 mm	13-900240	C
	BCD 2	black	15 mm	13-900241	C
	BCD 3	red	13 mm	13-900242	C
	BCDX 1	yellow	15 mm	13-900243	C
	BCDX 2	black	15 mm	13-900244	C
	BCDX 3	red	15 mm	13-900245	C
	BCD 1 Adapter pathfinder for handgrip length 100 mm			13-310511	F





TWIST DRILLS

	Description	Ø	Max. working length	REF	Price cat.
	Twist Drill 2.0/21	2.0 mm	21 mm	13-90022	D
	Twist Drill 2.0/30	2.0 mm	30 mm	13-90020	D
	Twist Drill 2.0/40	2.0 mm	40 mm	13-90019	D
	Twist Drill 2.5/21	2.5 mm	21 mm	13-90026	D
	Twist Drill 2.0 Cylindrical drill 2.0 mm for handgrip, length 110 mm		35 mm	13-310512	F
	Pilot drill for surgical handgrip. For chuck 2.35 mmd			13-310515	F
	Twist Drill 2.0/30 for surgical hand- grip. For chuck 2.35 mmd.		110 mm	13-310516	F

HARD METAL BONE CUTTER

	Description	Length	Code	REF	
	Hard metal bone cutter short	30 mm	SHMCS	13-90030	F
	Hard metal bone cutter long, for FG	36 mm	SHMCL	13-90031	F

INSERTION TOOLS AND ADAPTER

	Description	Code	REF	Price cat.
	For BECES® implants with Ø 3.5 mm + 4.5 mm	IT K	13-462320	C
	Insertion tool medium, for large head. Use with RAT2 and TW2.	IT2 BECES	13-900030	E
	For BECES® implants with Ø 3.6, 4.6, 5.5, 7.9, 10.5, 12 mm	IT2 S BECES	13-900038	E
	For BECES® implants with Ø 3.6, 4.6, 5.5, 7.9, 10.5, 12 mm. For handgrip REF 311431	AHB	13-900037	F
	Adapter for BECES 3.5/4.5 & KOC® For handgrip REF 311431	AHK	13-462319	D

WIRES FOR INTRA-ORAL WELDING



Description	Material	Ø	REF	Price cat.
Titanium wire, (5 pieces á 15cm / pack)	TiGr.2	1.5 mm	13-462001	B
Titanium wire, (5 pieces á 15cm / pack)	TiGr.2	2.0 mm	13-462002	B
Titanium wire, (5 pieces á 15cm / pack)	Ti6Al4V	2.0 mm	13-462003	B



TITANIUM CAPS FOR LASER CONNECTION

Multi-use titanium caps for:

- use in immediately lasered bridge frames, together with the bar profiles (without bar matrices)
- the radiological control of plastic modeling
- for direct Polymerization into the bridge prosthesis
- direct veneering with titanium ceramics
- material: Ti Grade 4

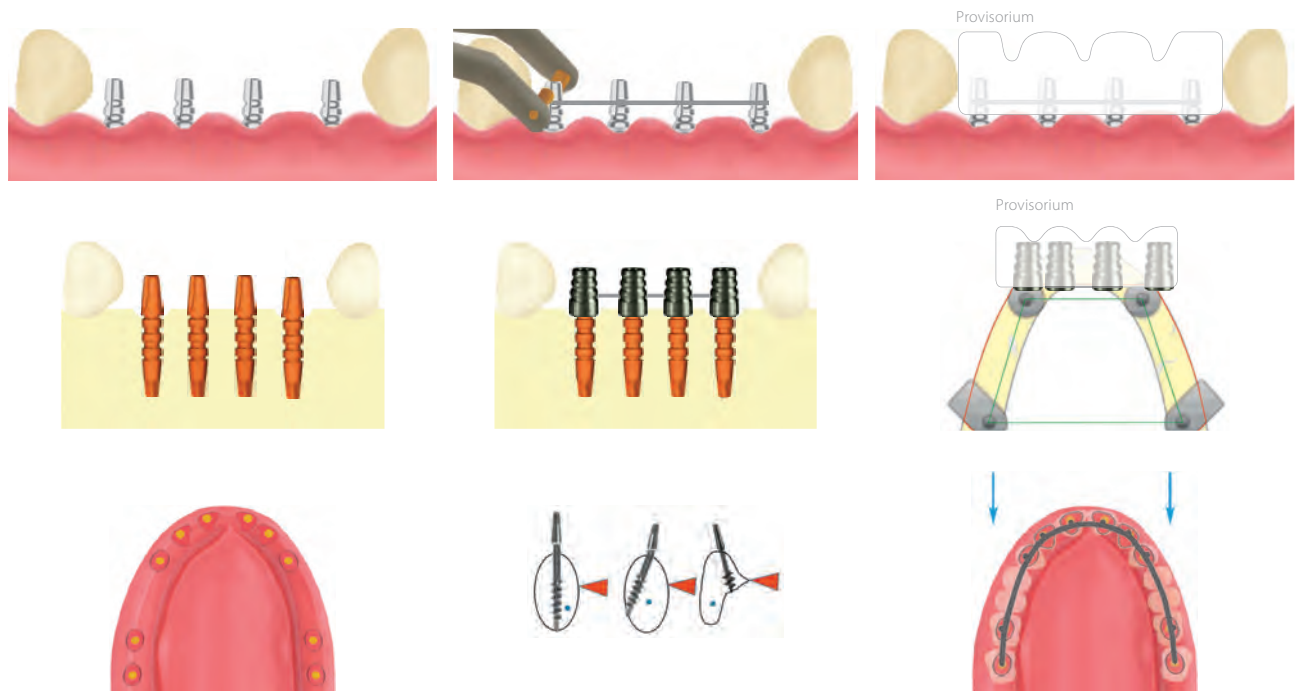

	Description	Code	REF	Price cat.
	Titanium cap, radio opaque for KOC, KOC B, BECES 3.5, BECES 4.5	MA4	13-462090	B
	Titanium cap, radio opaque for KOC X, KOC Plus, BECES 3.6, BECES 4.6-BECES 12	MA5	13-462093	B

INTRA-ORAL WELDING





Nanda S., Ihde S., Nanda P. Intra-oral welding-A useful adjunct in immediate loading implantology using BECES implants. CMF Impl. Dir. Vol 9, No.2, 13-24, 2014

SCANBODIES

	Description	Material	Systems	REF	Price cat.
	Scanbody-4 For small head	Peek	KOC, BECES	13-462054	B
	Scanbody-5 For large head	Peek	KOC, BECES	13-462055	B

CEMENTABLE ANGULATION ADAPTER (Ti6Al4V)

These adapters are mounted on **BECES**® implants to compensate for the insertion direction. Plastic cements are preferably used. The implant head must be roughened beforehand. The protruding head parts are then removed. The impression is taken directly on the adapter.

	Description	Code	REF	Price cat.
	Adapter, 15° for small head	AA15 KK	13-462036	C
	Adapter, 25° for small head	AA25 KK	13-462046	C
	Adapter short, for large head	AA5 15°	13-462052	C
	Adapter short, for large head	AA5 25°	13-462053	C

CASTABLE CROWN BASE

These adapters are used by the dental technician for modeling of bridge frames. In the metal try-in, the protruding head parts are removed by the dentist.

	Description	Height	Code	REF	Price cat.
	Adapter, pack of 5, reducible	7.5 mm	AAL 15 KK	13-462045	E

LAB ANALOGUE

	Description	Code	REF	Price cat.
	Abutment analogue for angulation adapter 15° and 25°	AAA	13-462049	B

CASTABLE ABUTMENT AND IMPRESSION TRANSFER

	Description	Code	REF	Price cat.
	Castable abutment and transfer for AAA (pack of 5)	PA AAA	13-462050	A

CEMENTING ABUTMENT

Replacement abutment for cementing. For BECES implants up to a shaft diameter of 2.1 mm. Larger shafts must be ground down. Allows the vertical correction of the abutment position. Mounting e.g. with Fuji Plus. With drain hole, machined surface. Material **Ti6Al4V**.

	Description	Code	REF	Price cat.
	Replacement abutment for BECES, internal diameter 2.15 mm	B21	13-900316	A

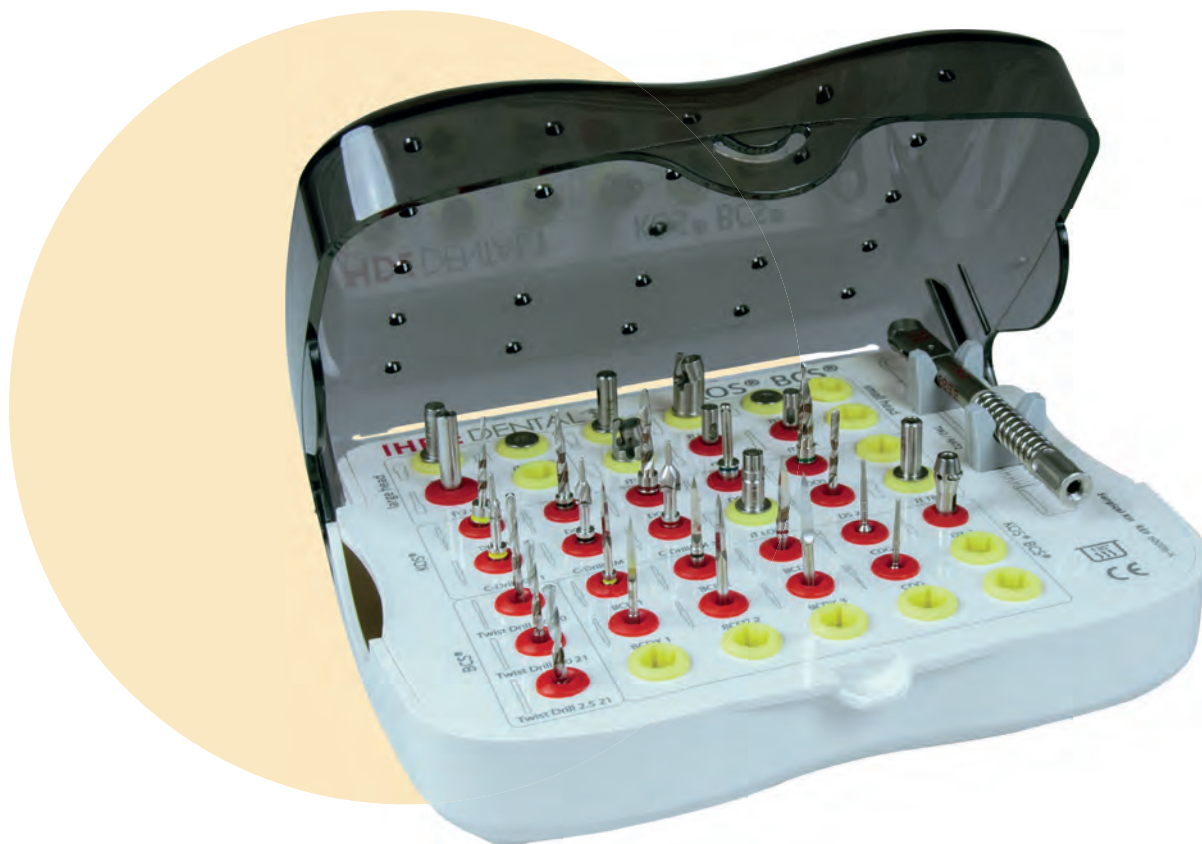
INSTRUMENT TRAY FOR KOC® & BECES®

Size of closed tray

B 175 mm **T** 145 mm **H** 65 mm

For all autoclaves. Autoclaveable up to 134° C,
not suitable for dry heat sterilizers.

Description	System	Head	REF	Description	System	REF	Price €
IT2 BECES	KOC/BECES	large	13-900030	Twist Drill 2.0 30	BECES	13-90020	
IT2 S BECES	KOC/BECES	large	13-900038	Twist Drill 2.0 21	BECES	13-90022	
IT2 W	KOC/BECES	large	13-900039	Twist Drill 2.5 21	BECES	13-90026	
IT K	KOC/BECES	small	13-462320	Twist Drill 1.8/23	BECES	13-90024	
ITS K	KOC/BECES	small	13-462322	BCD 1	KOC/BECES	13-900240	
ITW K	KOC/BECES	small	13-462331	BCD 2	KOC/BECES	13-900241	
ITWH K	KOC/BECES	small	13-462323	BCD 3	KOC/BECES	13-900242	
DOS 1	KOC		13-455311	BCDX 1	KOC/BECES	13-900243	
DOS 2	KOC		13-455312	BCDX 2	KOC/BECES	13-900244	
DOS 3	KOC		13-455313	BCDX 3	KOC/BECES	13-900245	
DOS 4	KOC		13-455314	CDG	KOC/BECES	13-420329	
DOS 5	KOC		13-455315	CDG	KOC/BECES	13-420329	
C-Drill KM 1	KOC		13-455300	DX 2	KOC/BECES	13-500704	
C-Drill KM 2	KOC		13-455301	TW 2	KOC/BECES	13-425402	
C-Drill KM 3	KOC		13-455302	Instrument tray empty		13-60006-K	upon request
IT LOC K	KOC		13-462333	Instrument tray with content		13-560006-K	upon request
DS 2	KOC		13-425001				
ITTB K	KOC		13-462327				

The content for the system KOC® is optional

INSERTION TOOLS

	Description	Type	Length	For implant	REF	Price cat.
	 IT K	long	20 mm	BECES, KOC, KOC B, KDS	13-462320	C
	 ITX K	extra long	45 mm	BECES, KOC, KOC B, KDS	13-462321	C
	 ITS K	short	7 mm	BECES, KOC, KOC B, KDS	13-462322	C
	 IT2 BECES	long	20 mm	BECES, KOC, KOC B, KDS	13-900030	H
	 IT2 S BECES	short	7 mm	BECES, KOC X, KOC Plus	13-900038	D
	 IT2W		23 mm	KOC, BECES	13-900039	C

STARTER TRAY

Autoclaveable up to 134° C, not suitable for dry heat sterilizers.
 This surgical kit contains all drills and tools for first works with the system BECES® and BECES® MU.
 Material: autoclaveable plastic.



Description	REF	Price €
IT K	13-462320	
ITS K	13-462322	
IT 2 BECES	13-900030	
IT 2 S BECES	13-900038	
BCD1	13-900240	
Twist Drill 2.0 21	13-90022	
Twist Drill 2.0 30	13-90020	
Twist Drill 2.5 21	13-90026	
Twist Drill 1.8/23	13-90024	
BCDX 1	13-900243	
HT 1.25	13-425100	optional content
ITX MU 15	13-418203	
Torque wrench TW2	13-425402	
Starter tray empty	13-60040-K	upon request
Starter tray with content	13-S60040-K	upon request

SINGLE PIECE IMPLANT PRO KIT

All trays are delivered **WITHOUT CONTENT**. The tray offers a quick overview of the different lengths and diameters at hand, as well as the available amount of the corresponding implants.

Description	Suitable for implant size	REF	Price cat.
Single Piece Implant Pro Kit BECES® 2.7 - 3.0	BECES® 2.7 - 3.0	13-60062-A	R
Single Piece Implant Pro Kit BECES® 3.5 - 4.5	BECES® 3.5 - 4.5	13-60066-A	R
Single Piece Implant Pro Kit BECES® 3.6 - 4.6	BECES® 3.6 - 4.6	13-60067-A	R
Single Piece Implant Pro Kit BECES® 4.5 - 4.6	BECES® 4.5 - 4.6	13-60064-A	R
Single Piece Implant Pro Kit BECES® 5.5 / 7 / 9 / 10.5 / 12	BECES® 5.5 / 7 / 9 / 10.5 / 12	13-60065-A	R

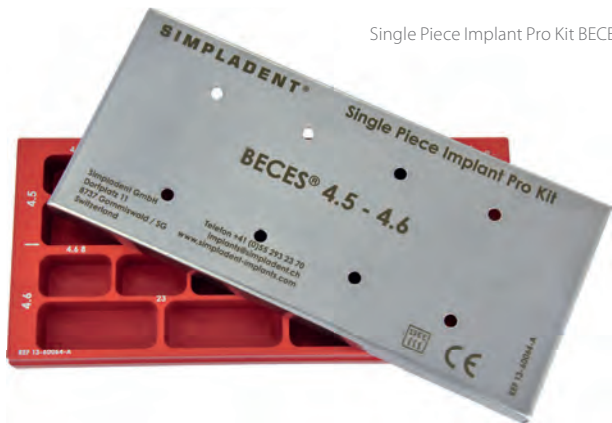

Quick and easy check of implant lengths thanks to the measurement chart

ZDI ZYGOMA SCREW IMPLANTS

ZDI implants are placed trans-sinually or below/inside the crista zygomatico-alveolaris, and in the alveolar crest of the maxilla. For cortical anchorage in the zygomatic bone. Depending on the anatomic situation the smooth parts of the implants are positioned below the Schneiderian membrane or below the oral mucosa. These implants are to be used only by trained surgeons. ZDI implants provide a bending area below the cementing abutment. Therefore they can be aligned with other abutments in the center of the crest after the implant has been placed. An additional vertical osteotomy may be necessary (see the drawing). This implant can be used in combination with tubero-ptyergoid screw implants (BECES®). The treatment protocol requires immediate splinting. **Material** Titanium alloy Ti6Al4V ELI.

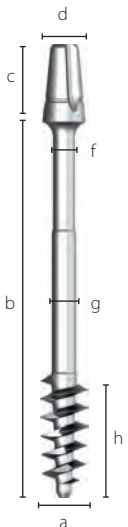
			Description	enossal Ø	Length	REF	Price cat.
a) max. diameter of thread	4.6 mm		Allfit ZDI 4.6 35	4.6	35	13-900100	F
b) enossal length	35 - 55 mm		Allfit ZDI 4.6 37.5	4.6	37.5	13-900101	F
c) abutment height	7 mm		Allfit ZDI 4.6 40	4.6	40	13-900102	F
d) max. abutment-Ø	3.9 mm		Allfit ZDI 4.6 42.5	4.6	42.5	13-900103	F
f) upper Ø of shaft	2.0 mm		Allfit ZDI 4.6 45	4.6	45	13-900104	F
g) Ø of shaft	2.2 mm		Allfit ZDI 4.6 47.5	4.6	47.5	13-900105	F
h) length of thread	10 mm		Allfit ZDI 4.6 50	4.6	50	13-900106	F
			Allfit ZDI 4.6 52.5	4.6	52.5	13-900107	F
		Allfit ZDI 4.6 55	4.6	55	13-900108	F	

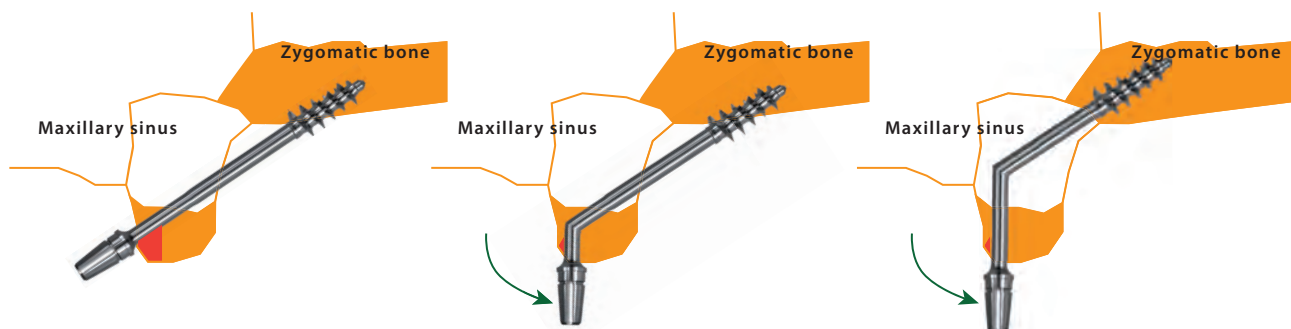

ZDI Implants may be used in a trans-sinusal or sub-mucosal manner. The abutment head is aligned with the tooth arch through bending.

TWIST DRILLS

	Description	REF	Price cat.
	Twist Drill 2.2 / 50 for Zygoma implants, SS	13-90021	D
	Twist Drill 2.2 / 55 for Zygoma implants, SS	13-90023	D
	Twist Drill 2.2 for handgrip to Zygoma implants. Length 100 mm	13-310514	F

ACCESSORIES FOR ZSI

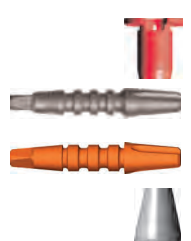
	Description	Einheit	Code	REF	Price cat.
	Impression post castable, POM Internally round	Pack of 5	TSPA 5	13-462030	B
	Double analogue metal		IA4/IAU	13-462112	A
	Double analogue plastic	Pack of 5	IA4/IAU	13-462111	B
	Castable part	Pack of 5	POB	13-462086	B

ZDI MU ZYGOMA SCREW IMPLANTS

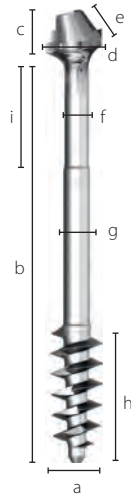

ZDI MU implants feature a pre-angulation of 15 degrees. **ZDI MU** may be bent additionally, using the insertion tool. In conjunction with the clinically possible rotational positions of the head, virtually all possible angulations can be realized. **ZDI MU** implants may be used by authorized users only. Material **Ti6Al4V**.

a) max. Ø of thread	4.6 mm
max. theoretical thread Ø	5.6 mm
b) enossal length	35 - 55 mm
c) abutment height	3.7 mm
d) platform Ø	4.8 mm
e) height of connecting part	2 mm
f) upper Ø of shaft	2.0 mm
g) Ø of shaft	2.2 mm
h) length of thread	10 mm
i) length of bending zone	10 mm



Description	enossal Ø	Length	REF	Price cat.
Allfit ZDI 4.6 35 MU	4.6	35	13-900110	N
Allfit ZDI 4.6 37.5 MU	4.6	37.5	13-900111	N
Allfit ZDI 4.6 40 MU	4.6	40	13-900112	N
Allfit ZDI 4.6 42.5 MU	4.6	42.5	13-900113	N
Allfit ZDI 4.6 45 MU	4.6	45	13-900114	N
Allfit ZDI 4.6 47.5 MU	4.6	47.5	13-900115	N
Allfit ZDI 4.6 50 MU	4.6	50	13-900116	N
Allfit ZDI 4.6 52.5 MU	4.6	52.5	13-900117	N
Allfit ZDI 4.6 55 MU	4.6	55	13-900118	N

ACCESSORIES FOR ZDI MU

	Description	Length	Code	REF	Price cat.
	Insertion tool Use with IT2 BECES, IT2 S BECES, AH MU. Tool: HT 1.25		ITX MU15	13-418203	G
	Adapter for large head, use with handgrip.	70 mm	AHB	13-900037	F
	Handgrip. For machine processing in the ultrasonic bath.	110 mm		13-311431	V



(The products of this catalogue are CE marked (class I) and CE 1936 marked (class IIa and IIb) according to 93/42/EC Directive).

Commercial products that are not monitored by our notified body are declared as third-party products.

Basal implants may only be used and operated by qualified persons with valid authorisation (para. 2 MedProdAnw Verordnung).

We are certified according to DIN EN ISO 13485 and Annex II of Directive 93/42 EEC.

The product dimensions shown in this brochure may differ from reality for technical reasons.

KOC® and **BECES®** are registered trademarks. Pat. Pend.

If implants are reprocessed, there is a risk of the development of infections, because no validated method for processing exists.

Implants therefore may not be reprocessed.

Compilation and explanation of symbols on the packaging:



Batch No.



Sterilized by radiation



Non-sterile



Intended for use by dentists or surgeons only



Single use product



Instruction for use



Expiry date



Store in a dry place



Store tightly keep closed



Do not use if packing is damaged



Do not resterilize



Manufacturer



Production date



Catalogue number

COMPRESSION SCREWS

KOC® M

KOC® MU

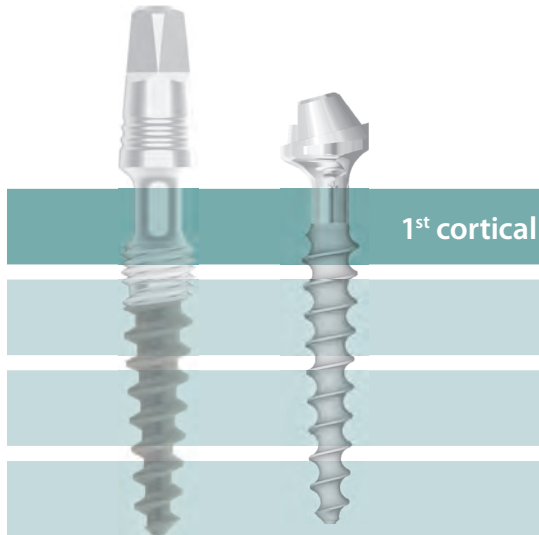

COMBINATION IMPLANT

KOC® PLUS



BASAL SCREW

BECES®

BECES® MU

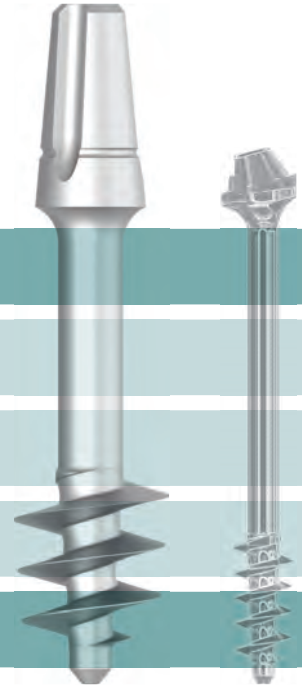

Simpladent GmbH
Dorfplatz 11
CH - 8737 Gommiswald / SG
SWITZERLAND

Phone +41 (0)55 293 23 70
implants@simpladent.ch
www.simpladent-implants.com

PLEASE ASK YOUR LOCAL DISTRIBUTOR FOR THE VALID PRICE LIST

SIMPLADENT®

EC REP

Dr. Ihde Dental GmbH
Erfurter Str. 19
D - 85386 Eching / München
Tel +49 (0)89 319 761 0
info@ihde-dental.de